

ANNEX I
SUMMARY OF PRODUCT CHARACTERISTICS

1. NAME OF THE MEDICINAL PRODUCT

NeoRecormon 500 IU solution for injection in pre-filled syringe
NeoRecormon 2000 IU solution for injection in pre-filled syringe
NeoRecormon 3000 IU solution for injection in pre-filled syringe
NeoRecormon 4000 IU solution for injection in pre-filled syringe
NeoRecormon 5000 IU solution for injection in pre-filled syringe
NeoRecormon 6000 IU solution for injection in pre-filled syringe
NeoRecormon 10,000 IU solution for injection in pre-filled syringe
NeoRecormon 20,000 IU solution for injection in pre-filled syringe
NeoRecormon 30,000 IU solution for injection in pre-filled syringe

2. QUALITATIVE AND QUANTITATIVE COMPOSITION

NeoRecormon 500 IU solution for injection in pre-filled syringe

One pre-filled syringe with 0.3 ml solution for injection contains 500 international units (IU) corresponding to 4.15 micrograms epoetin beta* (recombinant human erythropoietin).
One ml solution for injection contains 1667 IU epoetin beta.

NeoRecormon 2000 IU solution for injection in pre-filled syringe

One pre-filled syringe with 0.3 ml solution for injection contains 2000 international units (IU) corresponding to 16.6 micrograms epoetin beta* (recombinant human erythropoietin).
One ml solution for injection contains 6667 IU epoetin beta.

NeoRecormon 3000 IU solution for injection in pre-filled syringe

One pre-filled syringe with 0.3 ml solution for injection contains 3000 international units (IU) corresponding to 24.9 micrograms epoetin beta* (recombinant human erythropoietin).
One ml solution for injection contains 10,000 IU epoetin beta.

NeoRecormon 4000 IU solution for injection in pre-filled syringe

One pre-filled syringe with 0.3 ml solution for injection contains 4000 international units (IU) corresponding to 33.2 micrograms epoetin beta* (recombinant human erythropoietin).
One ml solution for injection contains 13,333 IU epoetin beta.

NeoRecormon 5000 IU solution for injection in pre-filled syringe

One pre-filled syringe with 0.3 ml solution for injection contains 5000 international units (IU) corresponding to 41.5 micrograms epoetin beta* (recombinant human erythropoietin).
One ml solution for injection contains 16,667 IU epoetin beta.

NeoRecormon 6000 IU solution for injection in pre-filled syringe

One pre-filled syringe with 0.3 ml solution for injection contains 6000 international units (IU) corresponding to 49.8 micrograms epoetin beta* (recombinant human erythropoietin).
One ml solution for injection contains 20,000 IU epoetin beta.

NeoRecormon 10,000 IU solution for injection in pre-filled syringe

One pre-filled syringe with 0.6 ml solution for injection contains 10,000 international units (IU) corresponding to 83 micrograms epoetin beta* (recombinant human erythropoietin).
One ml solution for injection contains 16,667 IU epoetin beta.

NeoRecormon 20,000 IU solution for injection in pre-filled syringe

One pre-filled syringe with 0.6 ml solution for injection contains 20,000 international units (IU) corresponding to 166 micrograms epoetin beta* (recombinant human erythropoietin).
One ml solution for injection contains 33,333 IU epoetin beta.

NeoRecormon 30,000 IU solution for injection in pre-filled syringe

One pre-filled syringe with 0.6 ml solution for injection contains 30,000 international units (IU) corresponding to 250 micrograms epoetin beta* (recombinant human erythropoietin).
One ml solution for injection contains 50,000 IU epoetin beta.

* produced in Chinese Hamster Ovary cells (CHO) by recombinant DNA technology

Excipient(s) with known effect

Phenylalanine (up to 0.3 mg/syringe)
Sodium (less than 1 mmol/syringe)

For the full list of excipients, see section 6.1.

3. PHARMACEUTICAL FORM

Solution for injection.
Colourless, clear to slightly opalescent solution.

4. CLINICAL PARTICULARS

4.1 Therapeutic indications

NeoRecormon is indicated for:

- Treatment of symptomatic anaemia associated with chronic renal failure in adult and paediatric patients.
- Prevention of anaemia of prematurity in infants with a birth weight of 750 to 1500 g and a gestational age of less than 34 weeks.
- Treatment of symptomatic anaemia in adult patients with non-myeloid malignancies receiving chemotherapy.
- Increasing the yield of autologous blood from patients in a pre-donation programme.
Its use in this indication must be balanced against the reported increased risk of thromboembolic events. Treatment should only be given to patients with moderate anaemia (Hb 10 - 13 g/dl [6.21 - 8.07 mmol/l], no iron deficiency) if blood conserving procedures are not available or insufficient when the scheduled major elective surgery requires a large volume of blood (4 or more units of blood for females or 5 or more units for males). See section 5.1

4.2 Posology and method of administration

Therapy with NeoRecormon should be initiated by physicians experienced in the above-mentioned indications. As anaphylactoid reactions were observed in isolated cases, it is recommended that the first dose be administered under medical supervision.

Posology

Treatment of symptomatic anaemia in adult and paediatric chronic renal failure patients
Anaemia symptoms and sequelae may vary with age, gender, and overall burden of disease; a physician's evaluation of the individual patient's clinical course and condition is necessary.

NeoRecormon should be administered either subcutaneously or intravenously in order to increase haemoglobin to not greater than 12 g/dl (7.5 mmol/l). Subcutaneous use is preferable in patients who are not receiving haemodialysis to avoid puncture of peripheral veins. In case of intravenous administration, the solution should be injected over approx. 2 minutes, e.g. in haemodialysis patients via the arteriovenous fistula at the end of dialysis.

Due to intra-patient variability, occasional individual haemoglobin values for a patient above and below the desired haemoglobin level may be observed. Haemoglobin variability should be addressed through dose management, with consideration for the haemoglobin target range of 10 g/dl (6.2 mmol/l) to 12 g/dl (7.5 mmol/l). A sustained haemoglobin level of greater than 12 g/dl (7.5 mmol/l) should be avoided; guidance for appropriate dose adjustment for when haemoglobin values exceeding 12 g/dl (7.5 mmol/l) are observed are described below.

A rise in haemoglobin of greater than 2 g/dl (1.25 mmol/l) over a four-week period should be avoided. If it occurs, appropriate dose adjustment should be made as provided. If the rate of rise in haemoglobin is greater than 2 g/dl (1.25 mmol/l) in one month or if the haemoglobin level is increasing and approaching 12 g/dl (7.45 mmol/l), the dose is to be reduced by approximately 25%. If the haemoglobin level continues to increase, therapy should be interrupted until the haemoglobin level begins to decrease, at which point therapy should be restarted at a dose approximately 25% below the previously administered dose.

Patients should be monitored closely to ensure that the lowest approved effective dose of NeoRecormon is used to provide adequate control of the symptoms of anaemia whilst maintaining a haemoglobin concentration below to 12 g/dl (7.45 mmol/l).

Caution should be exercised with escalation of NeoRecormon doses in patients with chronic renal failure. In patients with a poor haemoglobin response to NeoRecormon, alternative explanations for the poor response should be considered (see sections 4.4 and 5.1).

In the presence of hypertension or existing cardiovascular, cerebrovascular, or peripheral vascular diseases, the weekly increase in Hb and the target Hb should be determined individually taking into account the clinical picture.

Treatment with NeoRecormon is divided into two stages.

1. Correction phase

- Subcutaneous administration:
The initial dosage is 3 x 20 IU/kg body weight per week. The dosage may be increased every 4 weeks by 3 x 20 IU/kg and week if the increase of Hb is not adequate (< 0.25 g/dl per week). The weekly dose can also be divided into daily doses.
- Intravenous administration:
The initial dosage is 3 x 40 IU/kg per week. The dosage may be raised after 4 weeks to 80 IU/kg - three times per week - and by further increments of 20 IU/kg if needed, three times per week, at monthly intervals.

For both routes of administration, the maximum dose should not exceed 720 IU/kg per week.

2. Maintenance phase

To maintain an Hb of between 10 and 12 g/dl, the dosage is initially reduced to half of the previously administered amount. Subsequently, the dose is adjusted at intervals of one or two weeks individually for the patient (maintenance dose).

In the case of subcutaneous administration, the weekly dose can be given as one injection per week or in divided doses three or seven times per week. Patients who are stable on a once weekly dosing regimen may be switched to once every two weeks administration. In this case, dose increases may be necessary.

Results of clinical studies in children have shown that, on average, the younger the patients, the higher the NeoRecormon doses required. Nevertheless, the recommended dosing schedule should be followed as the individual response cannot be predicted.

Treatment with NeoRecormon is normally a long-term therapy. It can, however, be interrupted, if necessary, at any time. Data on the once weekly dosing schedule are based on clinical studies with a treatment duration of 24 weeks.

Prevention of anaemia of prematurity

The solution is administered subcutaneously at a dose of 3 x 250 IU/kg b.w. per week. Premature infants who have already been transfused by the start of treatment with NeoRecormon are not likely to benefit as much as untransfused infants. The recommended treatment duration is 6 weeks.

Treatment of symptomatic chemotherapy-induced anaemia in cancer patients

NeoRecormon should be administered by the subcutaneous route to patients with anaemia (e.g. haemoglobin concentration \leq 10g/dl (6.2 mmol/l). Anaemia symptoms and sequelae may vary with age, gender, and overall burden of disease; a physician's evaluation of the individual patient's clinical course and condition is necessary.

The weekly dose can be given as one injection per week or in divided doses 3 to 7 times per week.

The recommended initial dose is 30,000 IU per week (corresponding to approximately 450 IU/kg body weight per week, based on an average weighted patient).

Due to intra-patient variability, occasional individual haemoglobin values for a patient above and below the desired haemoglobin level may be observed. Haemoglobin variability should be addressed through dose management, with consideration for the haemoglobin target range of 10 g/dl (6.2 mmol/l) to 12 g/dl (7.5 mmol/l). A sustained haemoglobin level of greater than 12 g/dl (7.5 mmol/l) should be avoided; guidance for appropriate dose adjustment for when haemoglobin values exceeding 12 g/dl (7.5 mmol/l) are observed are described below.

If, after 4 weeks of therapy, the haemoglobin value has increased by at least 1 g/dl (0.62 mmol/l), the current dose should be continued. If the haemoglobin value has not increased by at least 1 g/dl (0.62 mmol/l), a doubling of the weekly dose should be considered. If, after 8 weeks of therapy, the haemoglobin value has not increased by at least 1 g/dl (0.62 mmol/l), response is unlikely, and treatment should be discontinued.

The therapy should be continued for up to 4 weeks after the end of chemotherapy.

The maximum dose should not exceed 60,000 IU per week.

Once the therapeutic objective for an individual patient has been achieved, the dose should be reduced by 25 to 50% in order to maintain haemoglobin at that level. Appropriate dose titration should be considered.

If the haemoglobin exceeds 12 g/dl (7.5 mmol/l), the dose should be reduced by approximately 25 to 50%. Treatment with NeoRecormon should be temporarily discontinued if haemoglobin levels exceed 13 g/dl (8.1 mmol/l). Therapy should be reinitiated at approximately 25% lower than the previous dose after haemoglobin levels fall to 12 g/dl (7.5 mmol/l) or below.

If the rise in haemoglobin is greater than 2 g/dl (1.3 mmol/l) in 4 weeks, the dose should be reduced by 25 to 50%.

Patients should be monitored closely to ensure that the lowest approved dose of NeoRecormon is used to provide adequate control of the symptoms of anaemia.

Treatment for increasing the amount of autologous blood

The solution is administered intravenously over approx. 2 minutes or subcutaneously.

NeoRecormon is administered twice weekly over 4 weeks. On those occasions where the patient's PCV allows blood donation, i.e. $PCV \geq 33\%$, NeoRecormon is administered at the end of blood donation.

During the entire treatment period, a PCV of 48% should not be exceeded.

The dosage must be determined by the surgical team individually for each patient as a function of the required amount of pre-donated blood and the endogenous red cell reserve:

1. The required amount of pre-donated blood depends on the anticipated blood loss, use of blood conserving procedures and the physical condition of the patient.

This amount should be that quantity which is expected to be sufficient to avoid homologous blood transfusions.

The required amount of pre-donated blood is expressed in units whereby one unit in the nomogram is equivalent to 180 ml red cells.

2. The ability to donate blood depends predominantly on the patient's blood volume and baseline PCV. Both variables determine the endogenous red cell reserve, which can be calculated according to the following formula.

$$\text{Endogenous red cell reserve} = \text{blood volume [ml]} \times (\text{PCV} - 33) \div 100$$

$$\text{Women: blood volume [ml]} = 41 \text{ [ml/kg]} \times \text{body weight [kg]} + 1200 \text{ [ml]}$$

$$\text{Men: blood volume [ml]} = 44 \text{ [ml/kg]} \times \text{body weight [kg]} + 1600 \text{ [ml]}$$

(body weight ≥ 45 kg)

The indication for treatment with NeoRecormon and, if given, the single dose, should be determined from the required amount of pre-donated blood and the endogenous red cell reserve according to the following graphs.

Female patients
Required amount of pre-donated blood [units]

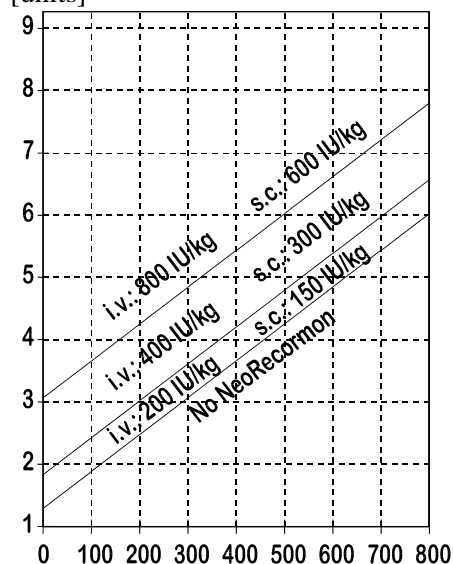

Endogenous red cell reserve [ml]

Male patients
Required amount of pre-donated blood [units]

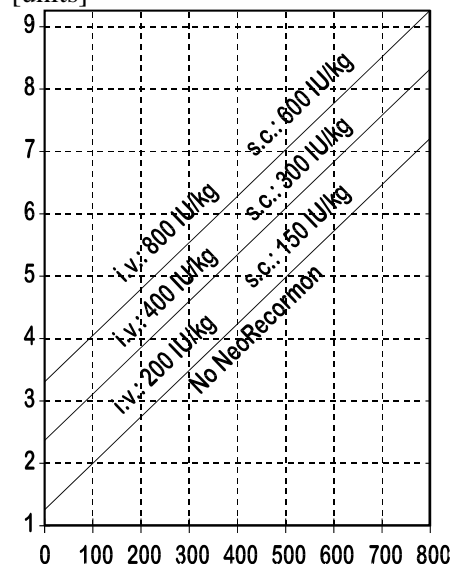

Endogenous red cell reserve [ml]

The single dose thus determined is administered twice weekly over 4 weeks. The maximum dose should not exceed 1600 IU/kg body weight per week for intravenous or 1200 IU/kg per week for subcutaneous administration.

Method of administration

The NeoRecormon pre-filled syringe is ready for use. Only solutions which are clear or slightly opalescent, colourless and practically free of visible particles may be injected.

NeoRecormon in pre-filled syringe is a sterile but unpreserved product. Under no circumstances should more than one dose be administered per syringe; the medicinal product is for single use only.

4.3 Contraindications

Hypersensitivity to the active substance or any of the excipients listed in section 6.1.

Poorly controlled hypertension.

In the indication “increasing the yield of autologous blood”: myocardial infarction or stroke in the month preceding treatment, unstable angina pectoris, increased risk of deep venous thrombosis such as history of venous thromboembolic disease.

4.4 Special warnings and precautions for use

Traceability

In order to improve the traceability of biological medicinal products, the name and the batch number of the administered product should be clearly recorded.

NeoRecormon should be used with caution in the presence of refractory anaemia with excess blasts in transformation, epilepsy, thrombocytosis, and chronic liver failure. Folic acid and vitamin B₁₂ deficiencies should be ruled out as they reduce the effectiveness of NeoRecormon.

Caution should be exercised with escalation of NeoRecormon doses in patients with chronic renal failure since high cumulative epoetin doses may be associated with an increased risk of mortality, serious cardiovascular and cerebrovascular events. In patients with a poor haemoglobin response to epoetins, alternative explanations for the poor response should be considered (see sections 4.2 and 5.1).

In order to ensure effective erythropoiesis, iron status should be evaluated for all patients prior to and during treatment, and supplementary iron therapy may be necessary and conducted in accordance with therapeutic guidelines.

Severe aluminium overload due to treatment of renal failure may compromise the effectiveness of NeoRecormon.

The indication for treatment with NeoRecormon of nephrosclerotic patients not yet undergoing dialysis should be defined individually, as a possible acceleration of progression of renal failure cannot be ruled out with certainty.

Pure red cell aplasia (PRCA)

PRCA caused by neutralising anti-erythropoietin antibodies has been reported in association with erythropoietin therapy, including NeoRecormon. These antibodies have been shown to cross-react with all erythropoietic proteins, and patients suspected or confirmed to have neutralising antibodies to erythropoietin should not be switched to NeoRecormon (see section 4.8).

PRCA in patients with Hepatitis C

A paradoxical decrease in haemoglobin and development of severe anaemia associated with low reticulocyte counts should prompt to discontinue treatment with epoetin and perform anti-erythropoietin antibody testing. Cases have been reported in patients with hepatitis C treated with

interferon and ribavirin, when epoetins are used concomitantly. Epoetins are not approved in the management of anaemia associated with hepatitis C.

Blood pressure monitoring

An increase in blood pressure or aggravation of existing hypertension, especially in cases of rapid PCV increase can occur. These increases in blood pressure can be treated with medicinal products. If blood pressure rises cannot be controlled by drug therapy, a transient interruption of NeoRecormon therapy is recommended. Particularly at the beginning of therapy, regular monitoring of the blood pressure is recommended, including between dialyses. Hypertensive crisis with encephalopathy-like symptoms may occur and require the immediate attention of a physician and intensive medical care. Particular attention should be paid to sudden stabbing migraine-like headaches as a possible warning sign.

Severe cutaneous adverse reactions (SCARs) including Stevens-Johnson syndrome (SJS) and toxic epidermal necrolysis (TEN), which can be life-threatening or fatal, have been reported in association with epoetin treatment (see section 4.8). More severe cases have been observed with long-acting epoetins. At the time of prescription, patients should be advised of the signs and symptoms and monitored closely for skin reactions. If signs and symptoms suggestive of these reactions appear, NeoRecormon should be withdrawn immediately and an alternative treatment considered. If the patient has developed a severe cutaneous skin reaction such as SJS or TEN due to the use of NeoRecormon, treatment with ESA must not be restarted in this patient at any time.

Chronic renal failure

In chronic renal failure patients, there may be a moderate dose-dependent rise in the platelet count within the normal range during treatment with NeoRecormon, especially after intravenous administration. This regresses during the course of continued therapy. It is recommended that the platelet count be monitored regularly during the first 8 weeks of therapy.

Haemoglobin concentration

In patients with chronic renal failure, maintenance haemoglobin concentration should not exceed the upper limit of the target haemoglobin concentration recommended in section 4.2. In clinical trials, an increased risk of death and serious cardiovascular events or cerebrovascular events including stroke was observed when erythropoiesis stimulating agents (ESAs) were administered to target a haemoglobin of greater than 12 g/dl (7.5 mmol/l).

Controlled clinical trials have not shown significant benefits attributable to the administration of epoetins when haemoglobin concentration is increased beyond the level necessary to control symptoms of anaemia and to avoid blood transfusion.

In premature infants there may be a slight rise in platelet counts, particularly up to day 12 - 14 of life, therefore platelets should be monitored regularly.

Effect on tumour growth

Epoetins are growth factors that primarily stimulate red blood cell production. Erythropoietin receptors may be expressed on the surface of a variety of tumour cells. As with all growth factors, there is a concern that epoetins could stimulate the growth of tumours. In several controlled studies, epoetins have not been shown to improve overall survival or decrease the risk of tumour progression in patients with anaemia associated with cancer.

In controlled clinical studies, use of NeoRecormon and other erythropoiesis-stimulating agents (ESAs) have shown:

- shortened time to tumour progression in patients with advanced head and neck cancer receiving radiation therapy when administered to target a haemoglobin of greater than 14 g/dl (8.7 mmol/l),

- shortened overall survival and increased deaths attributed to disease progression at 4 months in patients with metastatic breast cancer receiving chemotherapy when administered to target a haemoglobin of 12-14 g/dl (7.5-8.7 mmol/l),
- increased risk of death when administered to target a haemoglobin of 12 g/dl (7.5 mmol/l) in patients with active malignant disease receiving neither chemotherapy nor radiation therapy. ESAs are not indicated for use in this patient population.

In view of the above, in some clinical situations blood transfusion should be the preferred treatment for the management of anaemia in patients with cancer. The decision to administer recombinant erythropoietins should be based on a benefit-risk assessment with the participation of the individual patient, which should take into account the specific clinical context. Factors that should be considered in this assessment should include the type of tumour and its stage; the degree of anaemia; life-expectancy; the environment in which the patient is being treated; and patient preference (see section 5.1)

There may be an increase in blood pressure which can be treated with drugs. It is therefore recommended to monitor blood pressure, in particular in the initial treatment phase in cancer patients.

Platelet counts and haemoglobin level should also be monitored at regular intervals in cancer patients.

In patients in an *autologous blood pre-donation programme* there may be an increase in platelet count, mostly within the normal range. Therefore, it is recommended that the platelet count be determined at least once a week in these patients. If there is an increase in platelets of more than $150 \times 10^9/l$ or if platelets rise above the normal range, treatment with NeoRecormon should be discontinued.

In preterm infants, a potential risk of erythropoietin to cause retinopathy could not be excluded, therefore caution should be exercised and the decision to treat a preterm infant should be balanced against the potential benefit and risk of this treatment and available alternative options.

In *chronic renal failure* patients, an increase in heparin dose during haemodialysis is frequently required during the course of therapy with NeoRecormon as a result of the increased packed cell volume. Occlusion of the dialysis system is possible if heparinisation is not optimum.

Early shunt revision and thrombosis prophylaxis by administration of acetylsalicylic acid, for example, should be considered in chronic renal failure patients at risk of shunt thrombosis.

Serum potassium and phosphate levels should be monitored regularly during therapy with NeoRecormon. Potassium elevation has been reported in a few uraemic patients receiving NeoRecormon, though causality has not been established. If an elevated or rising potassium level is observed, then consideration should be given to ceasing administration of NeoRecormon until the level has been corrected.

For use of NeoRecormon in an autologous pre-donation programme, the official guidelines on principles of blood donation must be considered, in particular:

- only patients with a PCV $\geq 33\%$ (haemoglobin ≥ 11 g/dl [6.83 mmol/l]) should donate;
- special care should be taken with patients below 50 kg weight;
- the single volume drawn should not exceed approx. 12% of the patient's estimated blood volume.

Treatment should be reserved for patients in whom it is considered of particular importance to avoid homologous blood transfusion taking into consideration the risk/benefit assessment for homologous transfusions.

Misuse

Misuse by healthy persons may lead to an excessive increase in packed cell volume. This may be associated with life-threatening complications of the cardiovascular system.

Excipients

NeoRecormon in pre-filled syringe contains up to 0.3 mg phenylalanine/syringe as an excipient. Therefore, this should be taken into consideration in patients affected with severe forms of phenylketonuria.

This medicinal product contains less than 1 mmol sodium (23 mg) per syringe, i.e. essentially “sodium-free”.

4.5 Interaction with other medicinal products and other forms of interaction

The clinical results obtained so far do not indicate any interaction of NeoRecormon with other medicinal products.

Animal experiments revealed that epoetin beta does not increase the myelotoxicity of cytostatic medicinal products like etoposide, cisplatin, cyclophosphamide, and fluorouracil.

4.6 Fertility, pregnancy and lactation

Pregnancy

For epoetin beta no clinical data on exposed pregnancies are available. Caution should be exercised when prescribing to pregnant women.

Breast-feeding

It is unknown whether epoetin beta is excreted in human milk. A decision on whether to continue/discontinue breast-feeding or to continue/discontinue therapy with epoetin beta should be made taking into account the benefit of breast-feeding to the child and the benefit of epoetin beta therapy to the woman.

Fertility

Animal studies do not indicate direct or indirect harmful effects with respect to pregnancy, embryonal/foetal development, parturition or postnatal development (see section 5.3).

4.7 Effects on ability to drive and use machines

NeoRecormon has no influence on the ability to drive and use machines.

4.8 Undesirable effects

Summary of the safety profile

Based on results from clinical trials including 1725 patients, approximately 8% of patients treated with NeoRecormon are expected to experience adverse reactions.

Anaemic patients with chronic renal failure

The most frequent adverse reaction during treatment with NeoRecormon is an increase in blood pressure or aggravation of existing hypertension, especially in cases of rapid PCV increase (see section 4.4). Hypertensive crisis with encephalopathy-like symptoms (e.g. headaches and confused state, sensorimotor disorders - such as speech disturbance or impaired gait - up to tonic-clonic seizures) may also occur in individual patients with otherwise normal or low blood pressure (see section 4.4).

Shunt thromboses may occur, especially in patients who have a tendency to hypotension or whose arteriovenous fistulae exhibit complications (e.g. stenoses, aneurisms), see section 4.4. In most cases, a fall in serum ferritin values simultaneous with a rise in packed cell volume is observed (see section

4.4). In addition, transient increases in serum potassium and phosphate levels have been observed in isolated cases (see section 4.4).

In isolated cases, neutralising anti-erythropoietin antibody-mediated pure red cell aplasia (PRCA) associated with NeoRecormon therapy has been reported. In case anti-erythropoietin antibody-mediated PRCA is diagnosed, therapy with NeoRecormon must be discontinued and patients should not be switched to another erythropoietic protein (see section 4.4).

Adverse reactions are listed in Table 1 below.

Patients with cancer

Epoetin beta treatment-related headache and hypertension which can be treated with drugs are common (see section 4.4).

In some patients, a fall in serum iron parameters is observed (see section 4.4).

Clinical studies have shown a higher frequency of thromboembolic events in cancer patients treated with NeoRecormon compared to untreated controls or placebo. In patients treated with NeoRecormon, this incidence is 7% compared to 4% in controls; this is not associated with any increase in thromboembolic mortality compared with controls.

Adverse reactions are listed in Table 2 below.

Patients in an autologous blood pre-donation programme

Patients in an autologous blood pre-donation programme have been reported to show a slightly higher frequency of thromboembolic events. However, a causal relationship with treatment with NeoRecormon could not be established.

In placebo-controlled trials, temporary iron deficiency was more pronounced in patients treated with NeoRecormon than in controls (see section 4.4).

Adverse reactions are listed in Table 3 below.

Severe cutaneous adverse reactions (SCARs) including Stevens-Johnson syndrome (SJS) and toxic epidermal necrolysis (TEN), which can be life-threatening or fatal, have been reported in association with epoetin treatment (see section 4.4)

Tabulated list of adverse reactions

Adverse reactions are listed according to MedDRA system organ class and frequency category.

Frequency categories are defined using the following convention:

very common ($\geq 1/10$); common ($\geq 1/100$ to $< 1/10$); uncommon ($\geq 1/1,000$ to $< 1/100$); rare ($\geq 1/10,000$ to $< 1/1,000$); very rare ($< 1/10,000$); not known (cannot be estimated from the available data).

Table 1: Adverse reactions attributed to the treatment with NeoRecormon in controlled clinical trials in CKD patients

System organ class	Adverse reaction	Frequency
Vascular disorders	Hypertension	Common
	Hypertensive crisis	Uncommon
Nervous system disorders	Headache	Common
Blood and lymphatic system disorders	Shunt thrombosis	Rare
	Thrombocytosis	Very rare

Table 2: Adverse reactions attributed to the treatment with NeoRecormon in controlled clinical trials in cancer patients

System organ class	Adverse reaction	Frequency
Vascular disorders	Hypertension	Common
Blood and lymphatic system disorders	Thromboembolic event	Common
Nervous system disorders	Headache	Common

Table 3: Adverse reactions attributed to the treatment with NeoRecormon in controlled clinical trials in patients in an autologous blood pre-donation programme

System organ class	Adverse reaction	Frequency
Nervous system disorders	Headache	Common

Premature infants

A fall in serum ferritin values is very common (see section 4.4).

Description of selected adverse reactions

Rarely, epoetin beta treatment-related skin reactions such as rash, pruritus, urticaria or injection site reactions may occur. In very rare cases, epoetin beta treatment-related anaphylactoid reactions have been reported. However, in controlled clinical studies no increased incidence of hypersensitivity reactions was found.

In very rare cases, particularly when starting treatment, epoetin beta treatment-related flu-like symptoms such as fever, chills, headaches, pain in the limbs, malaise and/or bone pain have been reported. These reactions were mild or moderate in nature and subsided after a couple of hours or days.

Data from a controlled clinical trial with epoetin alfa or darbepoetin alfa, reported an incidence of stroke as common.

Reporting of suspected adverse reactions

Reporting suspected adverse reactions after authorisation of the medicinal product is important. It allows continued monitoring of the benefit/risk balance of the medicinal product. Healthcare professionals are asked to report any suspected adverse reactions via the national reporting system listed in [Appendix V](#).

4.9 Overdose

The therapeutic margin of NeoRecormon is very wide. Even at very high serum levels no symptoms of poisoning have been observed.

5. PHARMACOLOGICAL PROPERTIES

5.1 Pharmacodynamic properties

Pharmacotherapeutic group: antianemic, ATC code: B03XA01

Mechanism of action

Erythropoietin is a glycoprotein that stimulates the formation of erythrocytes from its committed progenitors. It acts as a mitosis stimulating factor and differentiation hormone. Epoetin beta, the active substance of NeoRecormon, is identical in its amino acid and carbohydrate composition to erythropoietin that has been isolated from the urine of anaemic patients.

The biological efficacy of epoetin beta has been demonstrated after intravenous and subcutaneous administration in various animal models *in vivo* (normal and uraemic rats, polycythaemic mice, dogs). After administration of epoetin beta, the number of erythrocytes, the Hb values and reticulocyte counts increase as well as the ⁵⁹Fe-incorporation rate.

An increased ³H-thymidine incorporation in the erythroid nucleated spleen cells has been found *in vitro* (mouse spleen cell culture) after incubation with epoetin beta.

Investigations in cell cultures of human bone marrow cells showed that epoetin beta stimulates erythropoiesis specifically and does not affect leucopoiesis. Cytotoxic actions of epoetin beta on bone marrow or on human skin cells were not detected.

After single dose administration of epoetin beta no effects on behaviour or locomotor activity of mice and circulatory or respiratory function of dogs were observed.

Clinical efficacy and safety

In a randomised, double-blind, placebo-controlled study of 4,038 chronic renal failure patients not on dialysis with type 2 diabetes and haemoglobin levels ≤ 11 g/dl, patients received either treatment with darbepoetin alfa to target haemoglobin levels of 13 g/dl or placebo (see section 4.4). The study did not meet either primary objective of demonstrating a reduction in risk for all-cause mortality, cardiovascular morbidity, or end-stage renal disease (ESRD). Analysis of the individual components of the composite endpoints showed the following HR (95% CI): death 1.05 (0.92, 1.21), stroke 1.92 (1.38, 2.68), congestive heart failure (CHF) 0.89 (0.74, 1.08), myocardial infarction (MI) 0.96 (0.75, 1.23), hospitalisation for myocardial ischaemia 0.84 (0.55, 1.27), ESRD 1.02 (0.87, 1.18).

Pooled post-hoc analyses of clinical studies with ESAs have been performed in CRF patients (on dialysis, not on dialysis, with or without diabetes). A tendency towards increased risk estimates for all-cause mortality, cardiovascular and cerebrovascular events associated with higher cumulative ESA doses independent of the diabetes or dialysis status was observed (see sections 4.2 and 4.4).

Erythropoietin is a growth factor that primarily stimulates red cell production. Erythropoietin receptors may be expressed on the surface of a variety of tumour cells.

Survival and tumour progression have been examined in five large controlled studies involving a total of 2833 patients, of which four were double-blind placebo-controlled studies and one was an open-label study. Two of the studies recruited patients who were being treated with chemotherapy. The target haemoglobin concentration in two studies was > 13 g/dl; in the remaining three studies it was 12 -14 g/dl. In the open-label study there was no difference in overall survival between patients treated with recombinant human erythropoietin and controls. In the four placebo-controlled studies the hazard ratios for overall survival ranged between 1.25 and 2.47 in favour of controls. These studies have shown a consistent unexplained statistically significant excess mortality in patients who have anaemia, associated with various common cancers, who received recombinant human erythropoietin compared to controls. Overall survival outcome in the trials could not be satisfactorily explained by differences in the incidence of thrombosis and related complications between those given recombinant human erythropoietin and those in the control group.

An individual patient data based meta-analysis, which included data from all 12 controlled clinical studies in anaemic cancer patients conducted with NeoRecormon (n=2301), showed an overall hazard ratio point estimate for survival of 1.13 in favour of controls (95% CI 0.87, 1.46). In patients with baseline haemoglobin ≤ 10 g/dl (n=899), the hazard ratio point estimate for survival was 0.98 (95% CI 0.68 to 1.40). An increased relative risk for thromboembolic events was observed in the overall population (RR 1.62, 95% CI: 1.13, 2.31).

A patient-level data analysis has also been performed on more than 13,900 cancer patients (chemo-, radio-, chemoradio- or no therapy) participating in 53 controlled clinical trials involving several epoetins. Meta-analysis of overall survival data produced a hazard ratio point estimate of 1.06 in favour of controls (95% CI: 1.00, 1.12; 53 trials and 13,933 patients) and for cancer patients receiving

chemotherapy, the overall survival hazard ratio was 1.04 (95% CI: 0.97, 1.11; 38 trials and 10,441 patients). Meta-analyses also indicate consistently a significantly increased relative risk of thromboembolic events in cancer patients receiving recombinant human erythropoietin (see section 4.4).

In very rare cases, neutralising anti-erythropoietin antibodies with or without pure red cell aplasia (PRCA) occurred during rHuEPO therapy.

5.2 Pharmacokinetic properties

Pharmacokinetic investigations in healthy volunteers and uraemic patients show that the half-life of intravenously administered epoetin beta is between 4 and 12 hours and that the distribution volume corresponds to one to two times the plasma volume. Analogous results have been found in animal experiments in uraemic and normal rats.

After subcutaneous administration of epoetin beta to uraemic patients, the protracted absorption results in a serum concentration plateau, whereby the maximum concentration is reached after an average of 12 - 28 hours. The terminal half-life is higher than after intravenous administration, with an average of 13 - 28 hours.

Bioavailability of epoetin beta after subcutaneous administration is between 23 and 42% as compared with intravenous administration.

5.3 Preclinical safety data

Non-clinical data reveal no special hazard for humans based on conventional studies of safety pharmacology, repeated dose toxicity, genotoxicity, and toxicity to reproduction.

A carcinogenicity study with homologous erythropoietin in mice did not reveal any signs of proliferative or tumourigenic potential.

6. PHARMACEUTICAL PARTICULARS

6.1 List of excipients

Urea,
Sodium chloride,
Polysorbate 20,
Sodium dihydrogen phosphate dihydrate,
Disodium phosphate dodecahydrate,
Calcium chloride dihydrate,
Glycine,
L-Leucine,
L-Isoleucine,
L-Threonine,
L-Glutamic acid,
L-Phenylalanine,
Water for injections.

6.2 Incompatibilities

In the absence of compatibility studies, this medicinal product must not be mixed with other medicinal products.

6.3 Shelf life

2 years.

6.4 Special precautions for storage

Store in a refrigerator (2°C – 8°C).

Keep the pre-filled syringe in the outer carton, in order to protect from light.

For the purpose of ambulatory use, the patient may remove the medicinal product from the refrigerator and store it at room temperature (not above 25°C) for one single period of up to 3 days.

6.5 Nature and contents of container

Pre-filled syringe (Type I glass) with a tip cap and a plunger stopper (teflonised rubber).

NeoRecormon 500 IU, NeoRecormon 2000 IU, NeoRecormon 3000 IU, NeoRecormon 4000 IU, NeoRecormon 5000 IU and NeoRecormon 6000 IU solution for injection in pre-filled syringe

Each pre-filled syringe contains 0.3 ml solution.

NeoRecormon 10,000 IU, NeoRecormon 20,000 IU and NeoRecormon 30,000 IU solution for injection in pre-filled syringe

Each pre-filled syringe contains 0.6 ml solution.

NeoRecormon is provided in the following pack-sizes:

NeoRecormon 500 IU solution for injection in pre-filled syringe

1 pre-filled syringe with 1 needle (30G1/2) or 6 pre-filled syringes with 6 needles (30G1/2).

NeoRecormon 2000 IU, NeoRecormon 3000 IU, NeoRecormon 4000 IU, NeoRecormon 5000 IU, NeoRecormon 6000 IU, NeoRecormon 10,000 IU and NeoRecormon 20,000 IU solution for injection in pre-filled syringe

1 pre-filled syringe with 1 needle (27G1/2) or 6 pre-filled syringes with 6 needles (27G1/2).

NeoRecormon 30,000 IU solution for injection in pre-filled syringe

1 pre-filled syringe with 1 needle (27G1/2) or 4 pre-filled syringes with 4 needles (27G1/2).

Not all pack sizes may be marketed.

6.6 Special precautions for disposal and other handling

First wash your hands!

1. Remove one syringe from the pack and check that the solution is clear, colourless and practically free from visible particles. Remove the cap from the syringe.
2. Remove one needle from the pack, fix it on the syringe and remove the protective cap from the needle.
3. Expel air from the syringe and needle by holding the syringe vertically and gently pressing the plunger upwards. Keep pressing the plunger until the amount of NeoRecormon in the syringe is as prescribed.
4. Clean the skin at the site of injection using an alcohol wipe. Form a skin fold by pinching the skin between thumb and forefinger. Hold the syringe barrel near to the needle and insert the needle into the skin fold with a quick, firm action. Inject the NeoRecormon solution. Withdraw the needle quickly and apply pressure over the injection site with a dry, sterile pad.

This medicinal product is for single use only. Any unused product or waste material should be disposed of in accordance with local requirements.

7. MARKETING AUTHORISATION HOLDER

Roche Registration GmbH
Emil-Barell-Strasse 1
79639 Grenzach-Wyhlen
Germany

8. MARKETING AUTHORISATION NUMBERS

EU/1/97/031/ 025-026
EU/1/97/031/029-030
EU/1/97/031/031-032
EU/1/97/031/033-034
EU/1/97/031/035-036
EU/1/97/031/037-038
EU/1/97/031/041-042
EU/1/97/031/043-044
EU/1/97/031/045-046

9. DATE OF FIRST AUTHORISATION/RENEWAL OF THE AUTHORISATION

Date of first authorisation: 16 July 1997
Date of latest renewal: 16 July 2007

10. DATE OF REVISION OF THE TEXT

Detailed information on this medicinal product is available on the website of the European Medicines Agency <http://www.ema.europa.eu>.

ANNEX II

- A. MANUFACTURER(S) OF THE BIOLOGICAL ACTIVE SUBSTANCE(S) AND MANUFACTURER(S) RESPONSIBLE FOR BATCH RELEASE**
- B. CONDITIONS OR RESTRICTIONS REGARDING SUPPLY AND USE**
- C. OTHER CONDITIONS AND REQUIREMENTS OF THE MARKETING AUTHORISATION**
- D. CONDITIONS OR RESTRICTIONS WITH REGARD TO THE SAFE AND EFFECTIVE USE OF THE MEDICINAL PRODUCT**

A. MANUFACTURER(S) OF THE BIOLOGICAL ACTIVE SUBSTANCE(S) AND MANUFACTURER(S) RESPONSIBLE FOR BATCH RELEASE

Name and address of the manufacturer(s) of the biological active substance(s)

Roche Diagnostics GmbH
Nonnenwald 2
D-82377 Penzberg
Germany

Name and address of the manufacturer(s) responsible for batch release

Roche Pharma AG
Emil-Barell-Strasse 1
D-79639 Grenzach-Wyhlen
Germany

B. CONDITIONS OR RESTRICTIONS REGARDING SUPPLY AND USE

Medicinal product subject to restricted medical prescription (see Annex I: Summary of Product Characteristics, section 4.2)

C. OTHER CONDITIONS AND REQUIREMENT OF THE MARKETING AUTHORISATION

• **Periodic safety update reports (PSURs)**

The requirements for submission of PSURs for this medicinal product are set out in the list of Union reference dates (EURD list) provided for under Article 107c(7) of Directive 2001/83/EC and any subsequent updates published on the European medicines web-portal.

D. CONDITIONS OR RESTRICTIONS WITH REGARD TO THE SAFE AND EFFECTIVE USE OF THE MEDICINAL PRODUCT

• **Risk management plan (RMP)**

The marketing authorisation holder (MAH) shall perform the required pharmacovigilance activities and interventions detailed in the agreed RMP presented in Module 1.8.2 of the marketing authorisation and any agreed subsequent updates of the RMP.

An updated RMP should be submitted:

- At the request of the European Medicines Agency;
- Whenever the risk management system is modified, especially as the result of new information being received that may lead to a significant change to the benefit/risk profile or as the result of an important (pharmacovigilance or risk minimisation) milestone being reached.

ANNEX III
LABELLING AND PACKAGE LEAFLET

A. LABELLING

PARTICULARS TO APPEAR ON THE OUTER PACKAGING

OUTER CARTON 500 IU PRE-FILLED SYRINGE

1. NAME OF THE MEDICINAL PRODUCT

NeoRecormon 500 IU solution for injection in pre-filled syringe
epoetin beta

2. STATEMENT OF ACTIVE SUBSTANCE(S)

1 pre-filled syringe contains 500 IU epoetin beta.

3. LIST OF EXCIPIENTS

1 syringe contains: Urea, sodium chloride, polysorbate 20, sodium dihydrogen phosphate dihydrate, disodium phosphate dodecahydrate, calcium chloride dihydrate, glycine, L-Leucine, L-Isoleucine, L-Threonine, L-glutamic acid, L-Phenylalanine, and water for injections.
Medicinal product contains phenylalanine and sodium, see leaflet for further information

4. PHARMACEUTICAL FORM AND CONTENTS

Solution for injection
1 pre-filled syringe (0.3 ml) and 1 needle (30G1/2)
6 pre-filled syringes (0.3 ml) and 6 needles (30G1/2)

5. METHOD AND ROUTE(S) OF ADMINISTRATION

Read the package leaflet before use.
Subcutaneous and intravenous use.

6. SPECIAL WARNING THAT THE MEDICINAL PRODUCT MUST BE STORED OUT OF THE SIGHT AND REACH OF CHILDREN

Keep out of the sight and reach of children.

7. OTHER SPECIAL WARNING(S), IF NECESSARY

8. EXPIRY DATE

EXP

9. SPECIAL STORAGE CONDITIONS

Store in a refrigerator
Keep the pre-filled syringe in the outer carton, in order to protect from light

10. SPECIAL PRECAUTIONS FOR DISPOSAL OF UNUSED MEDICINAL PRODUCTS OR WASTE MATERIALS DERIVED FROM SUCH MEDICINAL PRODUCTS, IF APPROPRIATE

11. NAME AND ADDRESS OF THE MARKETING AUTHORISATION HOLDER

Roche Registration GmbH
Emil-Barell-Strasse 1
79639 Grenzach-Wyhlen
Germany

12. MARKETING AUTHORISATION NUMBER(S)

EU/1/97/031/025 1 pre-filled syringe
EU/1/97/031/026 6 pre-filled syringes

13. BATCH NUMBER

Lot

14. GENERAL CLASSIFICATION FOR SUPPLY

Medicinal product subject to medical prescription

15. INSTRUCTIONS ON USE

16. INFORMATION IN BRAILLE

neorecormon 500 IU

17. UNIQUE IDENTIFIER – 2D BARCODE

2D barcode carrying the unique identifier included.

18. UNIQUE IDENTIFIER - HUMAN READABLE DATA

PC
SN
NN

MINIMUM PARTICULARS TO APPEAR ON SMALL IMMEDIATE PACKAGING UNITS

LABELS 500 IU pre-filled syringe

1. NAME OF THE MEDICINAL PRODUCT AND ROUTE(S) OF ADMINISTRATION

NeoRecormon 500 IU injection
epoetin beta
IV/SC use

2. METHOD OF ADMINISTRATION

Read the package leaflet before use.

3. EXPIRY DATE

EXP

4. BATCH NUMBER

Lot

5. CONTENTS BY WEIGHT, BY VOLUME OR BY UNIT

0.3 ml

6. OTHER

PARTICULARS TO APPEAR ON THE OUTER PACKAGING

OUTER CARTON 2000 IU pre-filled syringe

1. NAME OF THE MEDICINAL PRODUCT

NeoRecormon 2000 IU solution for injection in pre-filled syringe
epoetin beta

2. STATEMENT OF ACTIVE SUBSTANCE(S)

1 pre-filled syringe contains 2000 IU epoetin beta.

3. LIST OF EXCIPIENTS

1 syringe contains: Urea, sodium chloride, polysorbate 20, sodium dihydrogen phosphate dihydrate, disodium phosphate dodecahydrate, calcium chloride dihydrate, glycine, L-Leucine, L-Isoleucine, L-Threonine, L-glutamic acid, L-Phenylalanine, and water for injections.
Medicinal product contains phenylalanine and sodium, see leaflet for further information

4. PHARMACEUTICAL FORM AND CONTENTS

Solution for injection
1 pre-filled syringe (0.3 ml) and 1 needle (27G1/2)
6 pre-filled syringes (0.3 ml) and 6 needles (27G1/2)

5. METHOD AND ROUTE(S) OF ADMINISTRATION

Read the package leaflet before use.
Subcutaneous and intravenous use.

6. SPECIAL WARNING THAT THE MEDICINAL PRODUCT MUST BE STORED OUT OF THE SIGHT AND REACH OF CHILDREN

Keep out of the sight and reach of children.

7. OTHER SPECIAL WARNING(S), IF NECESSARY

8. EXPIRY DATE

EXP

9. SPECIAL STORAGE CONDITIONS

Store in a refrigerator
Keep the pre-filled syringe in the outer carton, in order to protect from light

10. SPECIAL PRECAUTIONS FOR DISPOSAL OF UNUSED MEDICINAL PRODUCTS OR WASTE MATERIALS DERIVED FROM SUCH MEDICINAL PRODUCTS, IF APPROPRIATE

11. NAME AND ADDRESS OF THE MARKETING AUTHORISATION HOLDER

Roche Registration GmbH
Emil-Barell-Strasse 1
79639 Grenzach-Wyhlen
Germany

12. MARKETING AUTHORISATION NUMBER(S)

EU/1/97/031/029 1 pre-filled syringe
EU/1/97/031/030 6 pre-filled syringes

13. BATCH NUMBER

Lot

14. GENERAL CLASSIFICATION FOR SUPPLY

Medicinal product subject to medical prescription

15. INSTRUCTIONS ON USE

16. INFORMATION IN BRAILLE

neorecormon 2000 IU

17. UNIQUE IDENTIFIER – 2D BARCODE

2D barcode carrying the unique identifier included.

18. UNIQUE IDENTIFIER - HUMAN READABLE DATA

PC
SN
NN

MINIMUM PARTICULARS TO APPEAR ON SMALL IMMEDIATE PACKAGING UNITS

LABELS 2000 IU pre-filled syringe

1. NAME OF THE MEDICINAL PRODUCT AND ROUTE(S) OF ADMINISTRATION

NeoRecormon 2000 IU injection
epoetin beta
IV/SC use

2. METHOD OF ADMINISTRATION

Read the package leaflet before use.

3. EXPIRY DATE

EXP

4. BATCH NUMBER

Lot

5. CONTENTS BY WEIGHT, BY VOLUME OR BY UNIT

0.3 ml

6. OTHER

PARTICULARS TO APPEAR ON THE OUTER PACKAGING

OUTER CARTON 3000 IU pre-filled syringe

1. NAME OF THE MEDICINAL PRODUCT

NeoRecormon 3000 IU solution for injection in pre-filled syringe
epoetin beta

2. STATEMENT OF ACTIVE SUBSTANCE(S)

1 pre-filled syringe contains 3000 IU epoetin beta.

3. LIST OF EXCIPIENTS

1 syringe contains: Urea, sodium chloride, polysorbate 20, sodium dihydrogen phosphate dihydrate, disodium phosphate dodecahydrate, calcium chloride dihydrate, glycine, L-Leucine, L-Isoleucine, L-Threonine, L-glutamic acid, L-Phenylalanine, and water for injections.
Medicinal product contains phenylalanine and sodium, see leaflet for further information

4. PHARMACEUTICAL FORM AND CONTENTS

Solution for injection
1 pre-filled syringe (0.3 ml) and 1 needle (27G1/2)
6 pre-filled syringes (0.3 ml) and 6 needles (27G1/2)

5. METHOD AND ROUTE(S) OF ADMINISTRATION

Read the package leaflet before use.
Subcutaneous and intravenous use.

6. SPECIAL WARNING THAT THE MEDICINAL PRODUCT MUST BE STORED OUT OF THE SIGHT AND REACH OF CHILDREN

Keep out of the sight and reach of children.

7. OTHER SPECIAL WARNING(S), IF NECESSARY

8. EXPIRY DATE

EXP

9. SPECIAL STORAGE CONDITIONS

Store in a refrigerator
Keep the pre-filled syringe in the outer carton, in order to protect from light

10. SPECIAL PRECAUTIONS FOR DISPOSAL OF UNUSED MEDICINAL PRODUCTS OR WASTE MATERIALS DERIVED FROM SUCH MEDICINAL PRODUCTS, IF APPROPRIATE

11. NAME AND ADDRESS OF THE MARKETING AUTHORISATION HOLDER

Roche Registration GmbH
Emil-Barell-Strasse 1
79639 Grenzach-Wyhlen
Germany

12. MARKETING AUTHORISATION NUMBER(S)

EU/1/97/031/031 1 pre-filled syringe
EU/1/97/031/032 6 pre-filled syringes

13. BATCH NUMBER

Lot

14. GENERAL CLASSIFICATION FOR SUPPLY

Medicinal product subject to medical prescription

15. INSTRUCTIONS ON USE

16. INFORMATION IN BRAILLE

neorecormon 3000 IU

17. UNIQUE IDENTIFIER – 2D BARCODE

2D barcode carrying the unique identifier included.

18. UNIQUE IDENTIFIER - HUMAN READABLE DATA

PC
SN
NN

MINIMUM PARTICULARS TO APPEAR ON SMALL IMMEDIATE PACKAGING UNITS

LABELS 3000 IU pre-filled syringe

1. NAME OF THE MEDICINAL PRODUCT AND ROUTE(S) OF ADMINISTRATION

NeoRecormon 3000 IU injection
epoetin beta
IV/SC use

2. METHOD OF ADMINISTRATION

Read the package leaflet before use.

3. EXPIRY DATE

EXP

4. BATCH NUMBER

Lot

5. CONTENTS BY WEIGHT, BY VOLUME OR BY UNIT

0.3 ml

6. OTHER

PARTICULARS TO APPEAR ON THE OUTER PACKAGING

OUTER CARTON 4000 IU pre-filled syringe

1. NAME OF THE MEDICINAL PRODUCT

NeoRecormon 4000 IU solution for injection in pre-filled syringe
epoetin beta

2. STATEMENT OF ACTIVE SUBSTANCE(S)

1 pre-filled syringe contains 4000 IU epoetin beta.

3. LIST OF EXCIPIENTS

1 syringe contains: Urea, sodium chloride, polysorbate 20, sodium dihydrogen phosphate dihydrate, disodium phosphate dodecahydrate, calcium chloride dihydrate, glycine, L-Leucine, L-Isoleucine, L-Threonine, L-glutamic acid, L-Phenylalanine, and water for injections.
Medicinal product contains phenylalanine and sodium, see leaflet for further information

4. PHARMACEUTICAL FORM AND CONTENTS

Solution for injection
1 pre-filled syringe (0.3 ml) and 1 needle (27G1/2)
6 pre-filled syringes (0.3 ml) and 6 needles (27G1/2)

5. METHOD AND ROUTE(S) OF ADMINISTRATION

Read the package leaflet before use.
Subcutaneous and intravenous use.

6. SPECIAL WARNING THAT THE MEDICINAL PRODUCT MUST BE STORED OUT OF THE SIGHT AND REACH OF CHILDREN

Keep out of the sight and reach of children.

7. OTHER SPECIAL WARNING(S), IF NECESSARY

8. EXPIRY DATE

EXP

9. SPECIAL STORAGE CONDITIONS

Store in a refrigerator
Keep the pre-filled syringe in the outer carton, in order to protect from light

10. SPECIAL PRECAUTIONS FOR DISPOSAL OF UNUSED MEDICINAL PRODUCTS OR WASTE MATERIALS DERIVED FROM SUCH MEDICINAL PRODUCTS, IF APPROPRIATE

11. NAME AND ADDRESS OF THE MARKETING AUTHORISATION HOLDER

Roche Registration GmbH
Emil-Barell-Strasse 1
79639 Grenzach-Wyhlen
Germany

12. MARKETING AUTHORISATION NUMBER(S)

EU/1/97/031/041 1 pre-filled syringe
EU/1/97/031/042 6 pre-filled syringes

13. BATCH NUMBER

Lot

14. GENERAL CLASSIFICATION FOR SUPPLY

Medicinal product subject to medical prescription

15. INSTRUCTIONS ON USE

16. INFORMATION IN BRAILLE

neorecormon 4000 IU

17. UNIQUE IDENTIFIER – 2D BARCODE

2D barcode carrying the unique identifier included.

18. UNIQUE IDENTIFIER - HUMAN READABLE DATA

PC
SN
NN

MINIMUM PARTICULARS TO APPEAR ON SMALL IMMEDIATE PACKAGING UNITS

LABELS 4000 IU pre-filled syringe

1. NAME OF THE MEDICINAL PRODUCT AND ROUTE(S) OF ADMINISTRATION

NeoRecormon 4000 IU injection
epoetin beta
IV/SC use

2. METHOD OF ADMINISTRATION

Read the package leaflet before use.

3. EXPIRY DATE

EXP

4. BATCH NUMBER

Lot

5. CONTENTS BY WEIGHT, BY VOLUME OR BY UNIT

0.3 ml

6. OTHER

PARTICULARS TO APPEAR ON THE OUTER PACKAGING

OUTER CARTON 5000 IU pre-filled syringe

1. NAME OF THE MEDICINAL PRODUCT

NeoRecormon 5000 IU solution for injection in pre-filled syringe
epoetin beta

2. STATEMENT OF ACTIVE SUBSTANCE(S)

1 pre-filled syringe contains 5000 IU epoetin beta.

3. LIST OF EXCIPIENTS

1 syringe contains: Urea, sodium chloride, polysorbate 20, sodium dihydrogen phosphate dihydrate, disodium phosphate dodecahydrate, calcium chloride dihydrate, glycine, L-Leucine, L-Isoleucine, L-Threonine, L-glutamic acid, L-Phenylalanine, and water for injections.
Medicinal product contains phenylalanine and sodium, see leaflet for further information

4. PHARMACEUTICAL FORM AND CONTENTS

Solution for injection
1 pre-filled syringe (0.3 ml) and 1 needle (27G1/2)
6 pre-filled syringes (0.3 ml) and 6 needles (27G1/2)

5. METHOD AND ROUTE(S) OF ADMINISTRATION

Read the package leaflet before use.
Subcutaneous and intravenous use.

6. SPECIAL WARNING THAT THE MEDICINAL PRODUCT MUST BE STORED OUT OF THE SIGHT AND REACH OF CHILDREN

Keep out of the sight and reach of children.

7. OTHER SPECIAL WARNING(S), IF NECESSARY

8. EXPIRY DATE

EXP

9. SPECIAL STORAGE CONDITIONS

Store in a refrigerator
Keep the pre-filled syringe in the outer carton, in order to protect from light

10. SPECIAL PRECAUTIONS FOR DISPOSAL OF UNUSED MEDICINAL PRODUCTS OR WASTE MATERIALS DERIVED FROM SUCH MEDICINAL PRODUCTS, IF APPROPRIATE

11. NAME AND ADDRESS OF THE MARKETING AUTHORISATION HOLDER

Roche Registration GmbH
Emil-Barell-Strasse 1
79639 Grenzach-Wyhlen
Germany

12. MARKETING AUTHORISATION NUMBER(S)

EU/1/97/031/033 1 pre-filled syringe
EU/1/97/031/034 6 pre-filled syringes

13. BATCH NUMBER

Lot

14. GENERAL CLASSIFICATION FOR SUPPLY

Medicinal product subject to medical prescription

15. INSTRUCTIONS ON USE

16. INFORMATION IN BRAILLE

neorecormon 5000 IU

17. UNIQUE IDENTIFIER – 2D BARCODE

2D barcode carrying the unique identifier included.

18. UNIQUE IDENTIFIER - HUMAN READABLE DATA

PC
SN
NN

MINIMUM PARTICULARS TO APPEAR ON SMALL IMMEDIATE PACKAGING UNITS

LABELS 5000 IU pre-filled syringe

1. NAME OF THE MEDICINAL PRODUCT AND ROUTE(S) OF ADMINISTRATION

NeoRecormon 5000 IU injection
epoetin beta
IV/SC use

2. METHOD OF ADMINISTRATION

Read the package leaflet before use

3. EXPIRY DATE

EXP

4. BATCH NUMBER

Lot

5. CONTENTS BY WEIGHT, BY VOLUME OR BY UNIT

0.3 ml

6. OTHER

PARTICULARS TO APPEAR ON THE OUTER PACKAGING

OUTER CARTON 6000 IU pre-filled syringe

1. NAME OF THE MEDICINAL PRODUCT

NeoRecormon 6000 IU solution for injection in pre-filled syringe
epoetin beta

2. STATEMENT OF ACTIVE SUBSTANCE(S)

1 pre-filled syringe contains 6000 IU epoetin beta.

3. LIST OF EXCIPIENTS

1 syringe contains: Urea, sodium chloride, polysorbate 20, sodium dihydrogen phosphate dihydrate, disodium phosphate dodecahydrate, calcium chloride dihydrate, glycine, L-Leucine, L-Isoleucine, L-Threonine, L-glutamic acid, L-Phenylalanine, and water for injections.
Medicinal product contains phenylalanine and sodium, see leaflet for further information

4. PHARMACEUTICAL FORM AND CONTENTS

Solution for injection
1 pre-filled syringe (0.3 ml) and 1 needle (27G1/2)
6 pre-filled syringes (0.3 ml) and 6 needles (27G1/2)

5. METHOD AND ROUTE(S) OF ADMINISTRATION

Read the package leaflet before use.
Subcutaneous and intravenous use.

6. SPECIAL WARNING THAT THE MEDICINAL PRODUCT MUST BE STORED OUT OF THE SIGHT AND REACH OF CHILDREN

Keep out of the sight and reach of children.

7. OTHER SPECIAL WARNING(S), IF NECESSARY

8. EXPIRY DATE

EXP

9. SPECIAL STORAGE CONDITIONS

Store in a refrigerator
Keep the pre-filled syringe in the outer carton, in order to protect from light

10. SPECIAL PRECAUTIONS FOR DISPOSAL OF UNUSED MEDICINAL PRODUCTS OR WASTE MATERIALS DERIVED FROM SUCH MEDICINAL PRODUCTS, IF APPROPRIATE

11. NAME AND ADDRESS OF THE MARKETING AUTHORISATION HOLDER

Roche Registration GmbH
Emil-Barell-Strasse 1
79639 Grenzach-Wyhlen
Germany

12. MARKETING AUTHORISATION NUMBER(S)

EU/1/97/031/043 1 pre-filled syringe
EU/1/97/031/044 6 pre-filled syringes

13. BATCH NUMBER

Lot

14. GENERAL CLASSIFICATION FOR SUPPLY

Medicinal product subject to medical prescription

15. INSTRUCTIONS ON USE

16. INFORMATION IN BRAILLE

neorecormon 6000 IU

17. UNIQUE IDENTIFIER – 2D BARCODE

2D barcode carrying the unique identifier included.

18. UNIQUE IDENTIFIER - HUMAN READABLE DATA

PC
SN
NN

MINIMUM PARTICULARS TO APPEAR ON SMALL IMMEDIATE PACKAGING UNITS

LABELS 6000 IU pre-filled syringe

1. NAME OF THE MEDICINAL PRODUCT AND ROUTE(S) OF ADMINISTRATION

NeoRecormon 6000 IU injection
epoetin beta
IV/SC use

2. METHOD OF ADMINISTRATION

Read the package leaflet before use.

3. EXPIRY DATE

EXP

4. BATCH NUMBER

Lot

5. CONTENTS BY WEIGHT, BY VOLUME OR BY UNIT

0.3 ml

6. OTHER

PARTICULARS TO APPEAR ON THE OUTER PACKAGING

OUTER CARTON 10,000 IU pre-filled syringe

1. NAME OF THE MEDICINAL PRODUCT

NeoRecormon 10,000 IU solution for injection in pre-filled syringe
epoetin beta

2. STATEMENT OF ACTIVE SUBSTANCE(S)

1 pre-filled syringe contains 10,000 IU epoetin beta.

3. LIST OF EXCIPIENTS

1 syringe contains: Urea, sodium chloride, polysorbate 20, sodium dihydrogen phosphate dihydrate, disodium phosphate dodecahydrate, calcium chloride dihydrate, glycine, L-Leucine, L-Isoleucine, L-Threonine, L-glutamic acid, L-Phenylalanine, and water for injections.
Medicinal product contains phenylalanine and sodium, see leaflet for further information

4. PHARMACEUTICAL FORM AND CONTENTS

Solution for injection
1 pre-filled syringe (0.6 ml) and 1 needle (27G1/2)
6 pre-filled syringes (0.6 ml) and 6 needles (27G1/2)

5. METHOD AND ROUTE(S) OF ADMINISTRATION

Read the package leaflet before use.
Subcutaneous and intravenous use.

6. SPECIAL WARNING THAT THE MEDICINAL PRODUCT MUST BE STORED OUT OF THE SIGHT AND REACH OF CHILDREN

Keep out of the sight and reach of children.

7. OTHER SPECIAL WARNING(S), IF NECESSARY

8. EXPIRY DATE

EXP

9. SPECIAL STORAGE CONDITIONS

Store in a refrigerator
Keep the pre-filled syringe in the outer carton, in order to protect from light

10. SPECIAL PRECAUTIONS FOR DISPOSAL OF UNUSED MEDICINAL PRODUCTS OR WASTE MATERIALS DERIVED FROM SUCH MEDICINAL PRODUCTS, IF APPROPRIATE

11. NAME AND ADDRESS OF THE MARKETING AUTHORISATION HOLDER

Roche Registration GmbH
Emil-Barell-Strasse 1
79639 Grenzach-Wyhlen
Germany

12. MARKETING AUTHORISATION NUMBER(S)

EU/1/97/031/035 1 pre-filled syringe
EU/1/97/031/036 6 pre-filled syringes

13. BATCH NUMBER

Lot

14. GENERAL CLASSIFICATION FOR SUPPLY

Medicinal product subject to medical prescription

15. INSTRUCTIONS ON USE

16. INFORMATION IN BRAILLE

neorecormon 10.000 IU

17. UNIQUE IDENTIFIER – 2D BARCODE

2D barcode carrying the unique identifier included.

18. UNIQUE IDENTIFIER - HUMAN READABLE DATA

PC
SN
NN

MINIMUM PARTICULARS TO APPEAR ON SMALL IMMEDIATE PACKAGING UNITS

LABELS 10,000 IU pre-filled syringe

1. NAME OF THE MEDICINAL PRODUCT AND ROUTE(S) OF ADMINISTRATION

NeoRecormon 10,000 IU injection
epoetin beta
IV/SC use

2. METHOD OF ADMINISTRATION

Read the package leaflet before use.

3. EXPIRY DATE

EXP

4. BATCH NUMBER

Lot

5. CONTENTS BY WEIGHT, BY VOLUME OR BY UNIT

0.6 ml

6. OTHER

PARTICULARS TO APPEAR ON THE OUTER PACKAGING

OUTER CARTON 20,000 IU pre-filled syringe

1. NAME OF THE MEDICINAL PRODUCT

NeoRecormon 20,000 IU solution for injection in pre-filled syringe
epoetin beta

2. STATEMENT OF ACTIVE SUBSTANCE(S)

1 pre-filled syringe contains 20,000 IU epoetin beta.

3. LIST OF EXCIPIENTS

1 syringe contains: Urea, sodium chloride, polysorbate 20, sodium dihydrogen phosphate dihydrate, disodium phosphate dodecahydrate, calcium chloride dihydrate, glycine, L-Leucine, L-Isoleucine, L-Threonine, L-glutamic acid, L-Phenylalanine, and water for injections.
Medicinal product contains phenylalanine and sodium, see leaflet for further information

4. PHARMACEUTICAL FORM AND CONTENTS

Solution for injection
1 pre-filled syringe (0.6 ml) and 1 needle (27G1/2)
6 pre-filled syringes (0.6 ml) and 6 needles (27G1/2)

5. METHOD AND ROUTE(S) OF ADMINISTRATION

Read the package leaflet before use.
Subcutaneous and intravenous use.

6. SPECIAL WARNING THAT THE MEDICINAL PRODUCT MUST BE STORED OUT OF THE SIGHT AND REACH OF CHILDREN

Keep out of the sight and reach of children.

7. OTHER SPECIAL WARNING(S), IF NECESSARY

8. EXPIRY DATE

EXP

9. SPECIAL STORAGE CONDITIONS

Store in a refrigerator
Keep the pre-filled syringe in the outer carton, in order to protect from light

10. SPECIAL PRECAUTIONS FOR DISPOSAL OF UNUSED MEDICINAL PRODUCTS OR WASTE MATERIALS DERIVED FROM SUCH MEDICINAL PRODUCTS, IF APPROPRIATE

11. NAME AND ADDRESS OF THE MARKETING AUTHORISATION HOLDER

Roche Registration GmbH
Emil-Barell-Strasse 1
79639 Grenzach-Wyhlen
Germany

12. MARKETING AUTHORISATION NUMBER(S)

EU/1/97/031/037 1 pre-filled syringe
EU/1/97/031/038 6 pre-filled syringes

13. BATCH NUMBER

Lot

14. GENERAL CLASSIFICATION FOR SUPPLY

Medicinal product subject to medical prescription

15. INSTRUCTIONS ON USE

16. INFORMATION IN BRAILLE

neorecormon 20.000 IU

17. UNIQUE IDENTIFIER – 2D BARCODE

2D barcode carrying the unique identifier included.

18. UNIQUE IDENTIFIER - HUMAN READABLE DATA

PC
SN
NN

MINIMUM PARTICULARS TO APPEAR ON SMALL IMMEDIATE PACKAGING UNITS

LABELS 20,000 IU pre-filled syringe

1. NAME OF THE MEDICINAL PRODUCT AND ROUTE(S) OF ADMINISTRATION

NeoRecormon 20,000 IU injection
epoetin beta
IV/SC use

2. METHOD OF ADMINISTRATION

Read the package leaflet before use.

3. EXPIRY DATE

EXP

4. BATCH NUMBER

Lot

5. CONTENTS BY WEIGHT, BY VOLUME OR BY UNIT

0.6 ml

6. OTHER

PARTICULARS TO APPEAR ON THE OUTER PACKAGING

OUTER CARTON 30,000 IU pre-filled syringe

1. NAME OF THE MEDICINAL PRODUCT

NeoRecormon 30,000 IU solution for injection in pre-filled syringe
epoetin beta

2. STATEMENT OF ACTIVE SUBSTANCE(S)

1 pre-filled syringe contains 30,000 IU epoetin beta.

3. LIST OF EXCIPIENTS

1 syringe contains: Urea, sodium chloride, polysorbate 20, sodium dihydrogen phosphate dihydrate, disodium phosphate dodecahydrate, calcium chloride dihydrate, glycine, L-Leucine, L-Isoleucine, L-Threonine, L-glutamic acid, L-Phenylalanine, and water for injections.
Medicinal product contains phenylalanine and sodium, see leaflet for further information

4. PHARMACEUTICAL FORM AND CONTENTS

Solution for injection
1 pre-filled syringe (0.6 ml) and 1 needle (27G1/2)
4 pre-filled syringes (0.6 ml) and 4 needles (27G1/2)

5. METHOD AND ROUTE(S) OF ADMINISTRATION

Read the package leaflet before use.
Subcutaneous and intravenous use.

6. SPECIAL WARNING THAT THE MEDICINAL PRODUCT MUST BE STORED OUT OF THE SIGHT AND REACH OF CHILDREN

Keep out of the sight and reach of children.

7. OTHER SPECIAL WARNING(S), IF NECESSARY

8. EXPIRY DATE

EXP

9. SPECIAL STORAGE CONDITIONS

Store in a refrigerator
Keep the pre-filled syringe in the outer carton, in order to protect from light

10. SPECIAL PRECAUTIONS FOR DISPOSAL OF UNUSED MEDICINAL PRODUCTS OR WASTE MATERIALS DERIVED FROM SUCH MEDICINAL PRODUCTS, IF APPROPRIATE

11. NAME AND ADDRESS OF THE MARKETING AUTHORISATION HOLDER

Roche Registration GmbH
Emil-Barell-Strasse 1
79639 Grenzach-Wyhlen
Germany

12. MARKETING AUTHORISATION NUMBER(S)

EU/1/97/031/045 1 pre-filled syringe
EU/1/97/031/046 4 pre-filled syringes

13. BATCH NUMBER

Lot

14. GENERAL CLASSIFICATION FOR SUPPLY

Medicinal product subject to medical prescription

15. INSTRUCTIONS ON USE

16. INFORMATION IN BRAILLE

neorecormon 30.000 IU

17. UNIQUE IDENTIFIER – 2D BARCODE

2D barcode carrying the unique identifier included.

18. UNIQUE IDENTIFIER - HUMAN READABLE DATA

PC
SN
NN

MINIMUM PARTICULARS TO APPEAR ON SMALL IMMEDIATE PACKAGING UNITS

LABELS 30,000 IU pre-filled syringe

1. NAME OF THE MEDICINAL PRODUCT AND ROUTE(S) OF ADMINISTRATION

NeoRecormon 30,000 IU injection
epoetin beta
IV/SC use

2. METHOD OF ADMINISTRATION

Read the package leaflet before use.

3. EXPIRY DATE

EXP

4. BATCH NUMBER

Lot

5. CONTENTS BY WEIGHT, BY VOLUME OR BY UNIT

0.6 ml

6. OTHER

B. PACKAGE LEAFLET

Package leaflet: Information for the user

NeoRecormon 500 IU
NeoRecormon 2000 IU
NeoRecormon 3000 IU
NeoRecormon 4000 IU
NeoRecormon 5000 IU
NeoRecormon 6000 IU
NeoRecormon 10,000 IU
NeoRecormon 20,000 IU
NeoRecormon 30,000 IU
solution for injection in pre-filled syringe
epoetin beta

Read all of this leaflet carefully before you start using this medicine because it contains important information for you.

- Keep this leaflet. You may need to read it again.
- If you have any further questions, ask your doctor or pharmacist.
- This medicine has been prescribed for you only. Do not pass it on to others. It may harm them, even if their signs or illness are the same as yours.
- If you get any side effects, talk to your doctor or pharmacist. This includes any possible side effects not listed in this leaflet. See section 4.

What is in this leaflet

1. What NeoRecormon is and what it is used for
2. What you need to know before you use NeoRecormon
3. How to use NeoRecormon
4. Possible side effects
5. How to store NeoRecormon
6. Content of the pack and other information

1. What NeoRecormon is and what it is used for

NeoRecormon is a clear, colourless solution for injection under the skin (*subcutaneously*) or into a vein (*intravenously*). It contains a hormone called *epoetin beta*, which stimulates the production of red blood cells. Epoetin beta is produced by a specialised genetic technology and works in exactly the same way as the natural hormone erythropoietin.

You must talk to your doctor if you do not feel better or if you feel worse.

NeoRecormon is indicated for:

- **Treating symptomatic anaemia caused by chronic kidney disease** (renal anaemia) in patients on dialysis, or not yet on dialysis.
- **Preventing anaemia in premature infants** (weighing 750 to 1500 g and born at less than 34 weeks).
- **Treating anaemia with related symptoms in adult cancer patients receiving chemotherapy**
- **Treating people donating their own blood before surgery.** The injections of epoetin beta will increase the amount of blood that can be taken from your body before surgery and given back during or after the operation (this is an *autologous transfusion*).

2. What you need to know before you use NeoRecormon

Do not use NeoRecormon

- **if you are allergic** to epoetin beta or any of the other ingredients of this medicine (listed in section 6)
- **if you have blood pressure problems** that cannot be controlled
- **if you are donating your own blood before surgery, and:**
 - you had a **heart attack** or **stroke** in the month before your treatment
 - you have unstable **angina pectoris** – new or increasing chest pain
 - you are **at risk of blood clots** in the veins (deep venous thrombosis) – for example, if you have had clots before.

If any of these apply to you, or might apply, **tell your doctor at once.**

Warnings and precautions

Talk to your doctor before using NeoRecormon

- **if your baby needs treatment with NeoRecormon, your baby will be carefully monitored for any potential effects on the eye**
- **if your anaemia does not improve** with epoetin treatment
- **if you are low in certain B vitamins** (*folic acid or vitamin B12*)
- **if you have very high levels of aluminium** in your blood
- **if your blood platelet count is high**
- **if you have chronic liver disease**
- **if you have epilepsy**
- **if you have developed anti-erythropoietin antibodies and pure red cell aplasia** (reduced or stopped production of red blood cells) during prior exposure to any erythropoietic substance. In this case you should not be switched to NeoRecormon.

Take special care with other products that stimulate red blood cell production:

NeoRecormon is one of a group of products that stimulate the production of red blood cells like the human protein erythropoietin does. Your doctor will always record the exact product you are using.

Serious skin reaction including Stevens-Johnson syndrome (SJS) and toxic epidermal necrolysis (TEN) have been reported in association with epoetin treatment.

SJS/TEN can appear initially as reddish target-like spots or circular patches often with central blisters on the trunk. Also, ulcers of mouth, throat, nose, genitals and eyes (red and swollen eyes) can occur. These serious skin rashes are often preceded by fever and/or flu-like symptoms. The rashes may progress to widespread peeling of the skin and life-threatening complications.

If you develop a serious rash or another of these skin symptoms, stop taking NeoRecormon and contact your doctor or seek medical attention immediately.

Special Warning:

During treatment with NeoRecormon

If you are a patient with chronic kidney disease, and particularly if you do not respond properly to NeoRecormon, your doctor will check your dose of NeoRecormon because repeatedly increasing your dose of NeoRecormon if you are not responding to treatment may increase the risk of having a problem of the heart or the blood vessels and could increase risk of myocardial infarction, stroke and death.

If you are a cancer patient, you should be aware that NeoRecormon may act as a blood cell growth factor and in some circumstances may have a negative impact on your cancer. Depending on your individual situation, a blood transfusion may be preferable. Please discuss this with your doctor.

If you are a nephrosclerotic patient and you are not on dialysis, your doctor will decide whether treatment is right for you. This is because one cannot rule out a possible acceleration of progression of kidney disease with absolute certainty.

Your doctor may do regular blood tests to check:

- your potassium levels. If you have high or rising potassium levels your doctor may reconsider your treatment
- your blood platelet count. The number of platelets can rise slightly to moderately during epoetin treatment, and this can cause changes in blood clotting.

If you are a kidney patient under haemodialysis, your doctor may adjust your dose of heparin. This should avoid a blockage in the tubing of the dialysis system.

If you are a kidney patient under haemodialysis and at risk of shunt thrombosis, blood clots (*thromboses*) may form in your *shunt* (vessel used for connection to the dialysis system). Your doctor might prescribe acetylsalicylic acid or modify the shunt.

If you are donating your own blood before surgery, your doctor will need to:

- check that you are capable of giving blood, especially if you weigh less than 50 kg
- check that you have a sufficient level of red blood cells (*haemoglobin of at least 11 g/dL*)
- make sure that only 12% of your blood will be donated at once.

Do not misuse NeoRecormon:

Misuse of NeoRecormon by healthy people may lead to an increase in blood cells and consequently thicken the blood. This can in turn lead to life-threatening complications of the heart or blood vessels.

Other medicines and NeoRecormon

Tell your doctor or pharmacist if you are taking, have recently taken or might take any other medicines, including medicines obtained without a prescription.

Pregnancy, breast-feeding and fertility

There is not much experience with NeoRecormon in pregnant women or women who are breast-feeding. Ask your doctor or pharmacist for advice before taking any medicine. NeoRecormon has not shown evidence of impaired fertility in animals. The potential risk for humans is unknown.

Driving and using machines

No effects on ability to drive or use machines have been observed.

NeoRecormon contains phenylalanine and sodium

This medicine contains phenylalanine. May be harmful for people with phenylketonuria.

If you have *phenylketonuria*, **talk to your doctor** about your treatment with **NeoRecormon**.

This medicine contains less than 1 mmol sodium (23 mg) per dose, i.e. essentially 'sodium-free'.

3. How to use NeoRecormon

Always use this medicine exactly as your doctor has told you. Check with your doctor or pharmacist if you are not sure.

Your doctor will use the lowest effective dose to control the symptoms of your anaemia.

If you do not respond adequately to NeoRecormon, your doctor will check your dose and will inform you if you need to change doses.

Treatment must be started under the supervision of your doctor.

Further injections are given by your doctor or, after you have been trained, you can inject NeoRecormon yourself (see instructions at the end of this leaflet.)

NeoRecormon can be injected under the skin in the abdomen, arm or thigh, or into a vein. Your doctor will decide which is best for you.

Your doctor will carry out regular blood tests to monitor how your anaemia is responding to treatment by measuring your haemoglobin level.

NeoRecormon dosing

The dose of NeoRecormon depends on your disease condition, the way the injection is given (under the skin or into a vein) and your body weight. Your doctor will work out the right dose for you. Your doctor will use the lowest effective dose to control the symptoms of your anaemia.

If you do not respond adequately to NeoRecormon, your doctor will check your dose and will inform you if you need to change doses of NeoRecormon.

- **Symptomatic anaemia caused by chronic kidney disease**

Your injections are given under the skin or into a vein. If the solution is given into your vein it should be injected over about 2 minutes, e.g. people on haemodialysis will receive the injection via the arteriovenous fistula at the end of dialysis.

People who are not on haemodialysis will usually have injections under the skin.

Treatment with NeoRecormon is divided into two stages:

a) Correcting the anaemia

The initial dose for injections under the skin is 20 IU per injection for every 1 kg of your body weight, given three times per week.

After 4 weeks, the doctor will do tests and, if the treatment response is not sufficient, your dose may be raised to 40 IU/kg per injection, given three times per week. The doctor may continue to increase your dose at monthly intervals if necessary.

The weekly dose can also be divided into daily doses.

The initial dose for injections into veins is 40 IU per injection for every 1 kg of your body weight, given three times per week.

After 4 weeks, the doctor will do tests and, if the treatment response is not sufficient, your dose may be raised to 80 IU/kg per injection, given three times per week. The doctor may continue to increase your dose at monthly intervals if necessary.

For both types of injection, the maximum dose should not exceed 720 IU for every 1 kg of your body weight per week.

b) Maintaining sufficient red blood cell levels

The maintenance dose: Once your red blood cells reach an acceptable level, the dose is reduced to half the dose used to correct the anaemia. The weekly dose can be given once per week or divided into three or seven doses per week. If your red blood cell level is stable on a once weekly dosing regimen, your dose may be switched to once every two weeks administration. In this case dose increases may be necessary.

Every one or two weeks, the doctor may adjust your dose to find your individual maintenance dose.

Children will start by following the same guidelines. In trials, children usually needed higher doses of NeoRecormon (the younger the child, the higher the dose).

Treatment with NeoRecormon is normally a long-term therapy. However, it can be interrupted at any time, if necessary.

- **Anaemia in premature infants**

Injections are given under the skin.

The initial dose is 250 IU per injection for every 1 kg the infant weighs, three times a week.

Premature infants who have been transfused before the start of treatment with NeoRecormon are not likely to benefit as much as untransfused infants.

The recommended treatment duration is 6 weeks.

- **Adults with symptomatic anaemia receiving chemotherapy for cancer**

Injections are given under the skin.

Your doctor may initiate treatment with NeoRecormon if your haemoglobin level is 10 g/dL or less. After initiation of therapy, your doctor will maintain your haemoglobin level between 10 and 12 g/dL.

The initial weekly dose is 30,000 IU. This may be given as one injection per week, or in divided doses as 3 to 7 injections per week. **Your doctor will take regular blood samples.** He or she may raise or lower your dose or interrupt your treatment according to the test results. The haemoglobin values should not exceed a value of 12 g/dL.

The therapy should be continued for up to 4 weeks after the end of chemotherapy.

The maximum dose should not exceed 60,000 IU per week.

- **People donating their own blood before surgery**

Injections are given into a vein over 2 minutes, or under the skin.

The dose of NeoRecormon depends on your condition, red blood cell levels and how much blood will be donated before surgery.

The dose worked out by your doctor will be given twice per week for 4 weeks. When you donate blood, NeoRecormon will be given to you at the end of a donation session.

The maximum dose should not exceed

- for injections into veins: 1600 IU for every 1 kg of your body weight per week
- for injections under the skin: 1200 IU for every 1 kg of your body weight per week.

If you inject too much NeoRecormon

Do not increase the dose your doctor has given you. If you think you have injected more NeoRecormon than you should, contact your doctor. It is unlikely to be serious. Even at very high blood levels, no symptoms of poisoning have been observed.

If you forget to use NeoRecormon

If you have missed an injection, or injected too little, talk to your doctor.

Do not take a double dose to make up for any forgotten doses.

If you have any further questions on the use of this medicine, ask your doctor or pharmacist.

4. Possible side effects

Like all medicines, this medicine can cause side effects, although not everybody gets them.

Side effects which can affect any patient

- **Most people (very common may affect more than 1 in 10 people) get lower levels of iron in their blood.** Almost all patients have to be treated with iron supplements during their NeoRecormon therapy.
- **Rarely (may affect up to 1 in 1,000 people), allergies or skin reactions,** such as rash or hives, itching or reactions around the injection site have occurred.
- **Very rarely (may affect up to 1 in 10,000 people) a severe form of allergic reaction** has occurred, especially just after an injection. It needs to be treated at once. If you get **unusual wheezing or difficulty breathing; swollen tongue, face or throat, or swelling around the injection site; if you feel light-headed or faint or if you collapse, call your doctor at once.**
- **Very rarely (may affect up to 1 in 10,000 people) people experienced flu-like symptoms, especially when they just started treatment. These include** fever, chills, headaches, pain in the limbs, bone pain and/or feeling generally unwell. These reactions were usually mild to moderate and went away within a few hours or days.
- Serious skin rashes including Stevens-Johnson syndrome and toxic epidermal necrolysis have been reported in association with epoetin treatment. These can appear as reddish target-like macules or circular patches often with central blisters on the trunk, skin peeling, ulcers of mouth, throat, nose, genitals and eyes and can be preceded by fever and flu-like symptoms. Stop using NeoRecormon if you develop these symptoms and contact your doctor or seek medical attention immediately. See also section 2.

Additional side effects in people with chronic kidney disease (renal anaemia)

- **Increase in blood pressure, worsening of existing high blood pressure and headaches** are the most common side effects (very common may affect more than 1 in 10 people). Your doctor will regularly check your blood pressure, particularly at the beginning of therapy. Your doctor may treat the high blood pressure with drugs or temporarily interrupt your NeoRecormon therapy.
- **Call a doctor at once** if you get **headaches, especially sudden, stabbing, migraine-like headaches, confusion, speech disturbance, unsteady walking, fits or convulsions.** These may be signs of severely elevated blood pressure (*hypertensive crisis*), even if your blood pressure is usually normal or low. It needs to be treated at once.
- **If you have low blood pressure or shunt complications,** you may be at risk of *shunt thrombosis* (a blood clot in the vessel used for connection to the dialysis system).
- **Very rarely (may affect up to 1 in 10,000 people), patients have had rising levels of potassium or phosphates** in the blood. This can be treated by your doctor.
- **Pure red cell aplasia (PRCA) caused by neutralising antibodies has been observed during erythropoietin therapy,** including in isolated cases during therapy with NeoRecormon. PRCA means that the body stopped or reduced the production of red blood cells. This causes severe anaemia, symptoms of which would include unusual tiredness and a lack of energy. If your body produces neutralising antibodies, your doctor will discontinue therapy with NeoRecormon, and determine the best course of action to treat your anaemia.

Additional side effects in adults receiving chemotherapy for cancer

- **Increase in blood pressure and headaches** may occasionally occur. Your doctor may treat the high blood pressure with drugs.
- **An increase in the occurrence of blood clots** has been observed.

Additional side effects in people donating their own blood before surgery

- **A slight increase in the occurrence of blood clots** has been observed.

Reporting of side effects

If you get any side effects, talk to your doctor or pharmacist. This includes any possible side effects not listed in this leaflet. You can also report side effects directly via [the national reporting system listed in Appendix V](#). By reporting side effects you can help provide more information on the safety of this medicine.

5. How to store NeoRecormon

- Keep this medicine out of the sight and reach of children.
- Do not use NeoRecormon after the expiry date which is stated on the carton and label.
- Store in a refrigerator (2°C – 8°C).
- The syringe can be removed from the refrigerator and left at room temperature for a single period of maximum 3 days (but not above 25°C).
- Keep the pre-filled syringe in the outer carton, in order to protect from light.
- Medicines should not be disposed of via wastewater or household waste. Ask your pharmacist how to dispose of medicines no longer required. These measures will help protect the environment.

6. Contents of the pack and other information

What NeoRecormon contains

- The active substance is epoetin beta. One pre-filled syringe contains either 500, 2000, 3000, 4000, 5000, 6000, 10,000, 20,000 or 30,000 IU (international units) epoetin beta in 0.3 ml or 0.6 ml solution.
- The other ingredients are:
urea, sodium chloride, polysorbate 20, sodium dihydrogen phosphate dihydrate, disodium phosphate dodecahydrate, calcium chloride dihydrate, glycine, L-Leucine, L-Isoleucine, L-Threonine, L-Glutamic acid, and L-Phenylalanine and water for injections.

What NeoRecormon looks like and contents of the pack

NeoRecormon is a solution in a pre-filled syringe for injection
The solution is colourless, clear to slightly opalescent.

NeoRecormon 500 IU, 2000 IU, 3000 IU, 4000 IU, 5000 IU and 6000 IU: Each pre-filled syringe contains 0.3 ml solution.

NeoRecormon 10,000 IU, 20,000 IU and 30,000 IU: Each pre-filled syringe contains 0.6 ml solution.

NeoRecormon is provided in the following pack-sizes:

NeoRecormon 500 IU

1 pre-filled syringe with 1 needle (30G1/2) or
6 pre-filled syringes with 6 needles (30G1/2).

NeoRecormon 2000 IU, 3000 IU, 4000 IU, 5000 IU, 6000 IU, 10,000 IU and 20,000 IU

1 pre-filled syringe with 1 needle (27G1/2) or
6 pre-filled syringes with 6 needles (27G1/2).

NeoRecormon 30,000 IU

1 pre-filled syringe with 1 needle (27G1/2) or
4 pre-filled syringes with 4 needles (27G1/2).

Not all pack sizes may be marketed.

Marketing Authorisation Holder

Roche Registration GmbH
Emil-Barell-Strasse 1
79639 Grenzach-Wyhlen
Germany

Manufacturer

Roche Pharma AG
Emil-Barell-Strasse 1
D-79639 Grenzach-Wyhlen
Germany

For any information about this medicinal product, please contact the local representative of the Marketing Authorisation Holder:

België/Belgique/Belgien

N.V. Roche S.A.
Tél/Tel: +32 (0) 2 525 82 11

България

Рош България ЕООД
Тел: +359 2 818 44 44

Česká republika

Roche s. r. o.
Tel: +420 - 2 20382111

Danmark

Roche a/s
Tlf: +45 - 36 39 99 99

Deutschland

Roche Pharma AG
Tel: +49 (0) 7624 140

Eesti

Roche Eesti OÜ
Tel: + 372 - 6 177 380

Ελλάδα

Roche (Hellas) A.E.
Τηλ: +30 210 61 66 100

España

Roche Farma S.A.
Tel: +34 - 91 324 81 00

France

Roche
Tél: +33 (0) 1 47 61 40 00

Hrvatska

Roche d.o.o.
Tel: +385 1 4722 333

Lietuva

UAB "Roche Lietuva"
Tel: +370 5 2546799

Luxembourg/Luxemburg

(Voir/siehe Belgique/Belgien)

Magyarország

Roche (Magyarország) Kft.
Tel: +36 - 1 279 4500

Malta

(See Ireland)

Nederland

Roche Nederland B.V.
Tel: +31 (0) 348 438050

Norge

Roche Norge AS
Tlf: +47 - 22 78 90 00

Österreich

Roche Austria GmbH
Tel: +43 (0) 1 27739

Polska

Roche Polska Sp.z o.o.
Tel: +48 - 22 345 18 88

Portugal

Roche Farmacêutica Química, Lda
Tel: +351 - 21 425 70 00

România

Roche România S.R.L.
Tel: +40 21 206 47 01

Ireland

Roche Products (Ireland) Ltd.
Tel: +353 (0) 1 469 0700

Ísland

Roche a/s
c/o Icepharma hf
Sími: +354 540 8000

Italia

Roche S.p.A.
Tel: +39 - 039 2471

Κύπρος

Γ.Α.Σταμάτης & Σια Λτδ.
Τηλ: +357 - 22 76 62 76

Latvija

Roche Latvija SIA
Tel: +371 - 6 7039831

Slovenija

Roche farmacevtska družba d.o.o.
Tel: +386 - 1 360 26 00

Slovenská republika

Roche Slovensko, s.r.o.
Tel: +421 - 2 52638201

Suomi/Finland

Roche Oy
Puh/Tel: +358 (0) 10 554 500

Sverige

Roche AB
Tel: +46 (0) 8 726 1200

United Kingdom (Northern Ireland)

Roche Products (Ireland) Ltd.
Tel: +44 (0) 1707 366000

This leaflet was last revised in <{MM/YYYY}> <{month YYYY}>

Detailed information on this medicine is available on the European Medicines Agency web site:
<http://www.ema.europa.eu>.

NeoRecormon pre-filled syringe Instructions for Use

The following instructions explain how to give an injection of NeoRecormon. Be sure that you read, understand and follow the Instructions for Use as well as the package leaflet before injecting NeoRecormon. Your healthcare provider will show you how to prepare and inject NeoRecormon properly before you use it for the first time. Do not inject yourself unless you have received training. Consult your healthcare provider if you require further information.

NeoRecormon can be administered through 2 manners, your doctor will decide which way is right for you:

- Intravenous administration (into the vein or vein port), only to be performed by healthcare professionals.
- Subcutaneous administration (under the skin).

Before you begin

- **Do not** take the needle cap off until you are ready to inject NeoRecormon.
- **Do not** try to take the syringe apart at any time.
- **Do not** reuse the same syringe.
- **Do not** use if the syringe has been dropped or damaged.
- **Do not** leave the syringe unattended.
- Keep the syringe and needle and the puncture-resistant or sharps disposal container out of reach of children.
- Contact your healthcare professional if you have any questions.

Storage Instructions

- Keep your unused syringe(s) in the original carton and store in a refrigerator at 2°C to 8°C.
- Keep your syringe out of direct sunlight.
- **Do not** freeze.
- **Do not** use if the syringe has been frozen.
- Always keep the syringe dry.

Supplies needed to give your injection

Included in the carton:

- NeoRecormon pre-filled syringe(s).

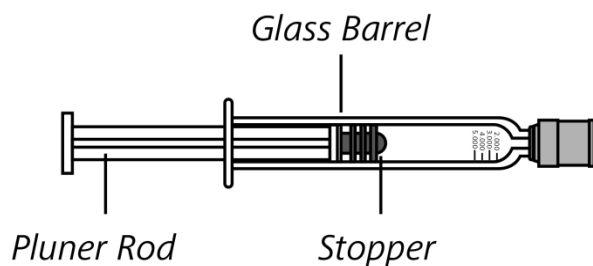

- Injection needle(s) (27G or 30G) (depending on the prescribed strengths of the medicine) with safety shield (used for priming, setting the dose and injecting the medicine).

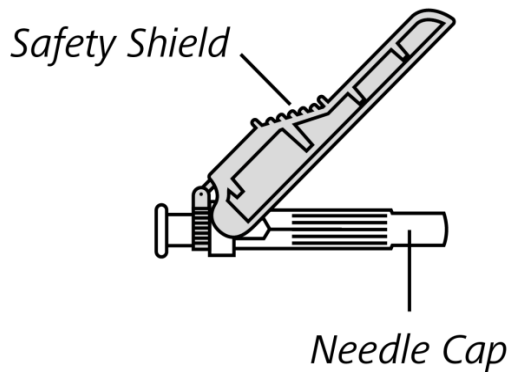

Note: Each carton contains either 1 syringe/1 needle, 4 syringes/4 needles or 6 syringes/6 needles.

- Instructions for Use and a package leaflet.

Not included in the box:

- 1 alcohol swab.
- 1 dry sterile pad.
- 1 puncture-resistant container or sharps container for safe disposal of rubber cap, needle cap and used syringe.

Preparing for injection

- 1 Find a well-lighted, clean, flat, working surface.
 - Take the carton with the syringe(s) and needle(s) out of the refrigerator
- 2 Check the carton has not been damaged and check the expiration date on the carton has not passed.
 - **Do not** use if the expiration date has passed, if the syringe is dropped or damaged, or if the carton appears to be tampered with. In this case, proceed to *step 19* and contact your healthcare provider.
- 3 Take one syringe out of the carton and one needle from the needle box. Be careful when taking out the syringe. Make sure you always hold the syringe as shown in the picture below.
 - **Do not** flip the carton upside down to remove the syringe.
 - **Do not** handle the syringe by holding the plunger or needle cap.

Remark: If you have a multipack, put the carton with the remaining syringe(s) and needle(s) back into the refrigerator

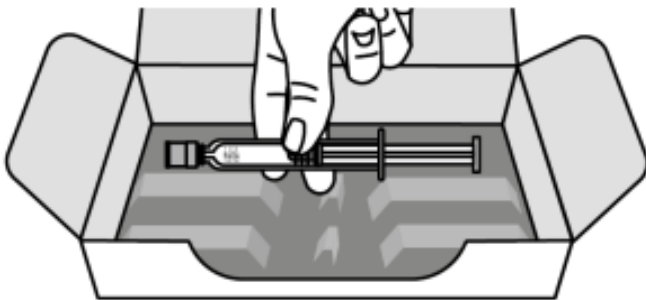

- 4 Inspect the syringe and needle closely
 - Check the syringe and needle for any damage. **Do not** use the syringe if you have dropped the syringe or if any part of the syringe appears to be damaged.

- Check the expiration date on the syringe and the needle. **Do not** use the syringe or the needle if the expiration date has passed.
- Check the liquid in the syringe. The liquid should be clear and colourless. **Do not** use the syringe if the liquid is cloudy, discoloured, or has particles.

5 Place the syringe on a clean, flat surface.

- Set aside the syringe for 30 minutes so it can warm up on its own to room temperature. Leave the needle cap on while it warms up.
- **Do not** speed up the warming process in any way, and **do not** put the syringe in a microwave or in warm water.

Remark: *If the syringe does not reach room temperature, this could cause the injection to feel uncomfortable and make it hard to push the plunger.*

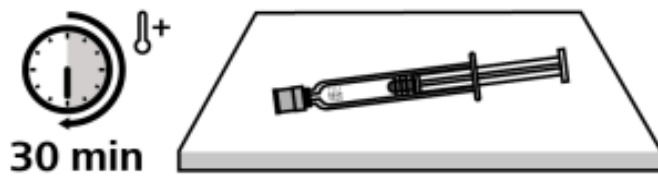

6 Attach the needle to the syringe.

- Remove the needle from its blister.
- Pull the rubber cap off the end of the syringe (A).
- Dispose of the rubber cap in a puncture-resistant or sharps disposal container immediately.
- **Do not** touch the tip of the syringe.
- **Do not** push or pull the plunger.
- Hold the syringe by the barrel and push the needle onto the syringe (B).
- Gently twist until it is fully attached (C)

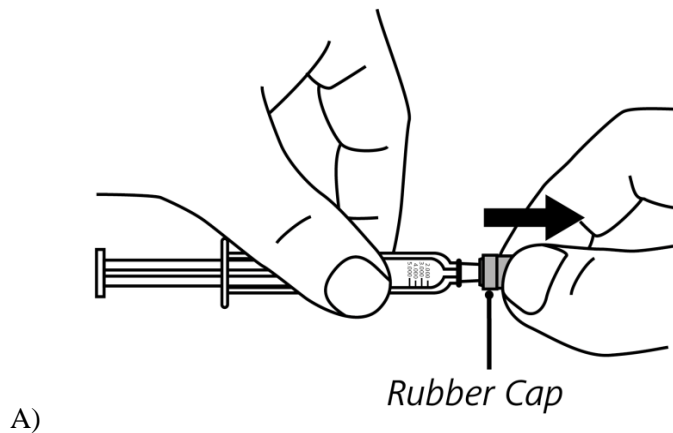

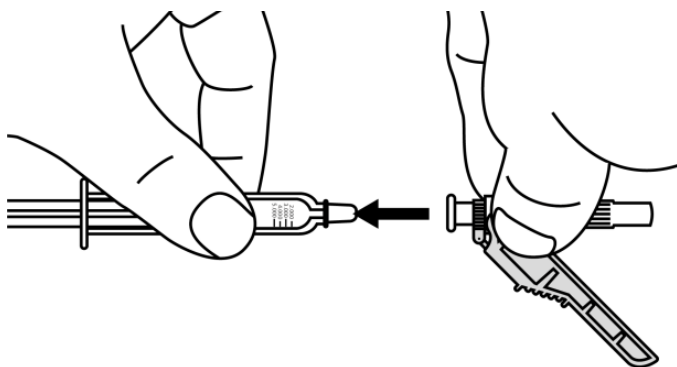

B)

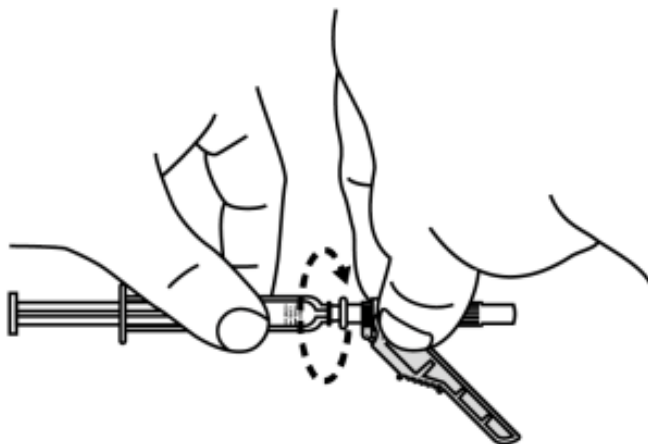

C)

- 7 Place the syringe on a clean, flat surface until ready for use.
- 8 Wash your hands with soap and water.
- 9 Choose an injection site:
 - The recommended injection sites are the top of your thigh or the lower part of your abdomen below the belly button. **Do not** inject within the 5 cm (2 inches) area directly around your belly button.
 - Choose a different injection site for each new injection.
 - **Do not** inject into moles, scars, bruises, or areas where the skin is tender, red, hard or not intact.
 - **Do not** inject into vein or into a muscle

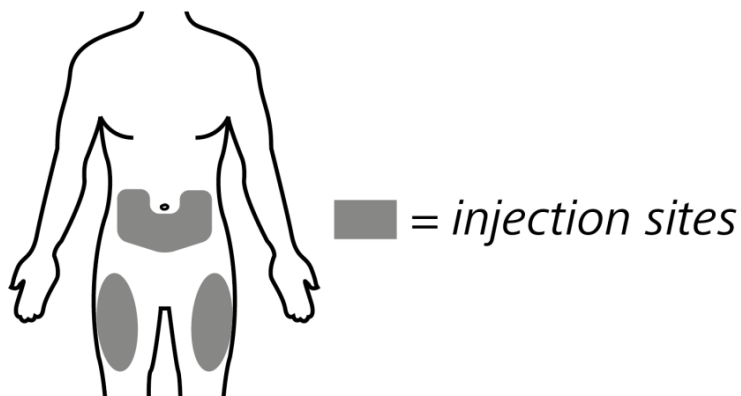

10 Wipe the injection site with an alcohol swab and let it air dry for 10 seconds.

- **Do not** fan or blow on the cleaned area.
- **Do not** touch the injection site again before giving the injection.



Administering the subcutaneous injection

11 Move the safety shield away from the needle towards the syringe barrel.

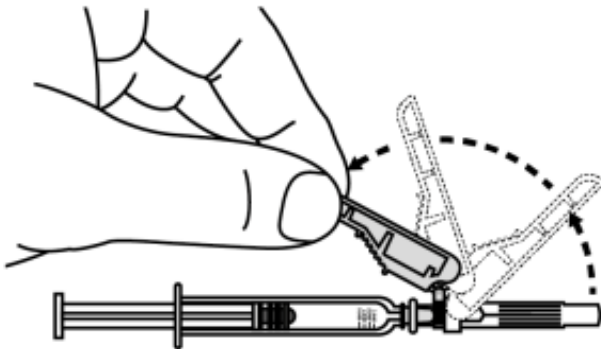

12 Hold the syringe and needle tightly at the hub and carefully pull the injection needle cap away from the syringe. Use the syringe within 5 minutes of removing the cap; otherwise, the needle may clog.

- **Do not** hold the plunger while you remove the needle cap.
- **Do not** touch the needle after removing the needle cap.
- **Do not** re-cap the needle.

Throw away the needle cap in a sharps disposal container immediately.

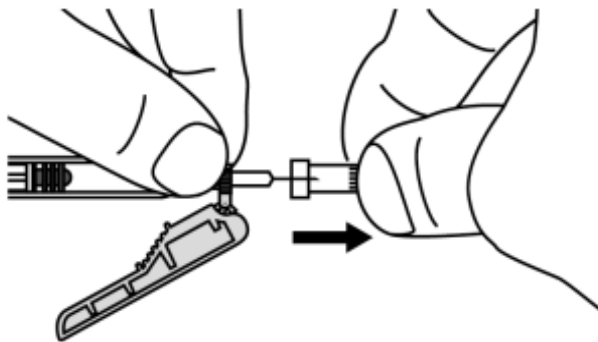

13 Hold the syringe with the needle pointing up. Remove the larger air bubbles by gently tapping the syringe barrel with your fingers until the air bubbles rise to the top of the syringe. Then, slowly push the plunger up to push the air bubbles out of the syringe.

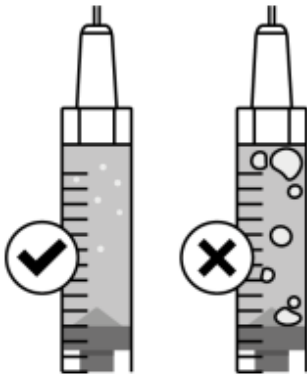

14 Adjust to your prescribed dose by slowly pushing the plunger.

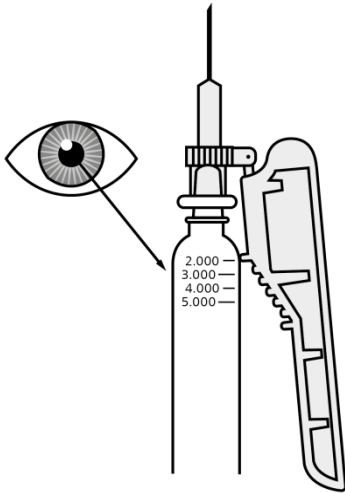

15 Pinch the selected injection site and fully insert the needle at a 45° to 90° angle with a quick, firm action.

- **Do not** touch the plunger while inserting the needle into the skin
- **Do not** insert the needle through clothing.

Once the needle is inserted, release the pinch and hold the syringe tightly in place.

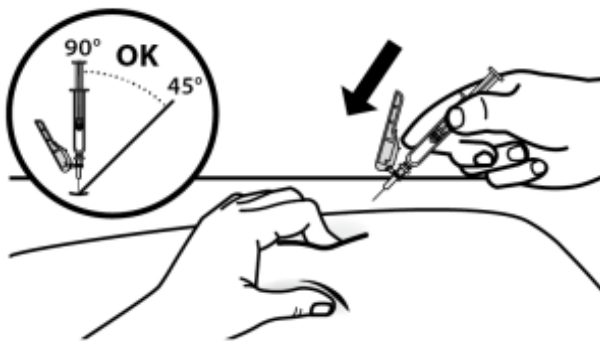

- 16 Slowly inject your prescribed dose by gently pushing the plunger all the way down
- Remove the needle and syringe from the injection site at the same angle as inserted.

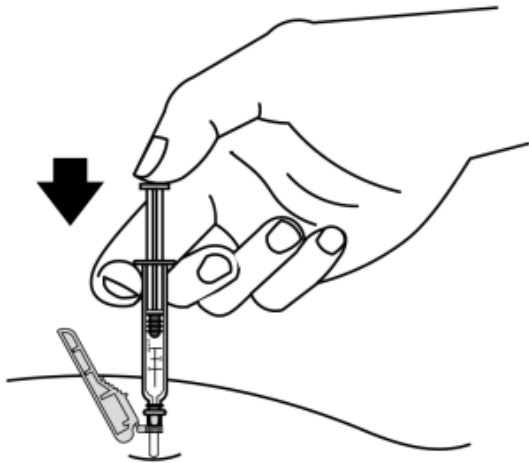

After the injection

- 17 There may be a little bleeding at the injection site. You can press a dry sterile pad over the injection site. **Do not** rub the injection site.

- If needed, you may cover the injection site with a small bandage.
- In case of skin contact with medicine, wash the area that touched the medicine with water.

- 18 Move the safety shield forward 90°, away from the syringe barrel (A). Holding the syringe with one hand, press the safety shield down against a flat surface with a firm, quick motion until you hear a “click” (B).

- If you do not hear a click, look to see that the needle is fully covered by the safety shield.
- Keep your fingers behind the safety shield and away from the needle at all times.

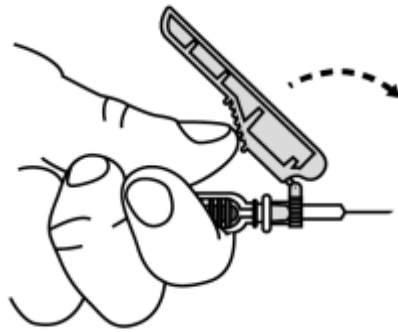

A)

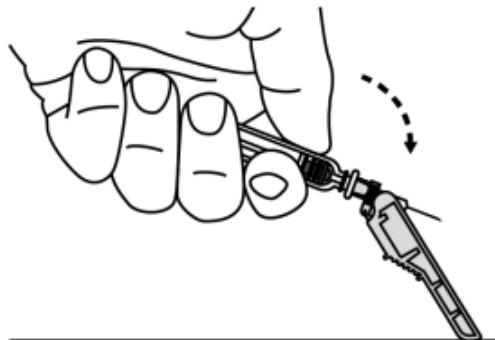

B)

19 Put your used syringe in a sharps disposal container right away after use.

- **Do not** try to remove the used injection needle from the used syringe.
- **Do not** recap the injection needle.
- **Do not** throw away (dispose of) the syringe in your household trash.

Important: Always keep the sharps disposal container out of the reach of children.

<----->
--->

Instructions for Use intended for healthcare professional only

The following Instructions for Use explain how to give an intravenous injection of NeoRecormon. Be sure that you read, understand and follow the Instructions for Use as well as the package leaflet before injecting NeoRecormon.

Administering the intravenous injection

Preparing for injection: follow steps 1 to 8

9 Select a vein. Change vein with each injection to prevent soreness in one spot.

- **Do not** inject into a red or swollen area.
- **Do not** inject into a muscle.

Clean the skin above the vein with an alcohol swab and let dry.

- **Do not** fan or blow on the cleaned area.
- **Do not** touch the injection site again before giving the injection.

10 Prepare the syringe and needle: follow steps 11 to 14

15 Insert the needle into the vein.

- **Do not** hold or push on the plunger while inserting needle.

16 Slowly inject the prescribed dose by gently pushing the plunger all the way down. Remove the needle and syringe from the injection site at the same angle as inserted.

After the injection: follow steps 17 to 19

Administering the intravenous injection via injection port

Preparing for injection: follow steps 1 to 8.

9 Clean the skin above the injection port with an alcohol swab and let dry.

Clean the injection port as instructed by the provider.

- **Do not** fan or blow on the cleaned area.
- **Do not** touch the injection site again before giving the injection.

10 Prepare the syringe and needle: follow steps 11 to 14.

15 Insert the needle into the injection port (follow the instruction of the injection port provider)

- **Do not** hold or push on the plunger while inserting needle.

16 Slowly inject the prescribed dose by gently pushing the plunger all the way down.

Remove the needle and syringe from the injection port at the same angle as inserted.

After the injection: follow steps 17 to 19.